

# OUTES

# OUTES

# HEAT PUMP

HEATING | COOLING | HOT WATER



**ZHEJIANG ZHONGGUANG ELECTRICAL CO., LTD.**

ADD: No. 96 Yunjing Road, Shuige Industry Area, Lishui City, Zhejiang, China.

Tel: +86 574-88164801 Fax: +86 574-88164809

Web: [www.outes.com](http://www.outes.com)

# 2023





## ABOUT US



OUTES was established in 2006, specializing in sales, R&D and manufacturing air conditioner, Cooling & Heating heat pump, Hot Water heat pump, Swimming Pool heat pump, Commercial heat pump, Fan Coils, Air Ventilation Unit, Water Purification Equipment and Pressure Water Tank.



OUTES industry park has 500,000m<sup>2</sup> with 350+ R&D engineers, 2000 employees, and the annual production capacity is 500,000 pcs. OUTES has its own workshops for heat ex-changers, metal punching, painting, copper tube preassembly and PCB controller with world-class production lines and equipment. 90% of components are made by its own.

OUTES intelligent laboratory group approved by CNAS, TUV and BV. Laboratory group has 8000m<sup>2</sup> with 50 laboratories. The test include Enthalpy, Low Ambient, Noises, Safety, Reliability, Water-Spray, Transportation Labs and etc. The test capacity is from 1HP to 200HP.



OUTES has reputation in domestic market. With 3000 distributors, 1000 After-sales Service Center and 10 local warehouse. OUTES is the partner of China Aerospace and China High-speed Railway. OUTES is experienced to offer integrated solutions for cooling, heating, hot water, Air ventilation and Water Purification for the hotel, University, factory, mine field, residential building, commercial building and etc.

OUTES has certificates of ISO9001, ISO14001, OHSAS18001, CE, RoHS etc. Our products have exported to overseas markets all over the world.

Laboratories: **50+**

R&D Engineers: **350+**

Laboratory Group Area: **800m<sup>2</sup>**

Industry Park Area: **500,000m<sup>2</sup>**

Annual Sales Turnover: **3Billions**

Employees: **2000+**

Domestic Distributors: **3000+**

Domestic After-sales Centers: **1000+**

Annual Production Capacity: **1000,000PCS**

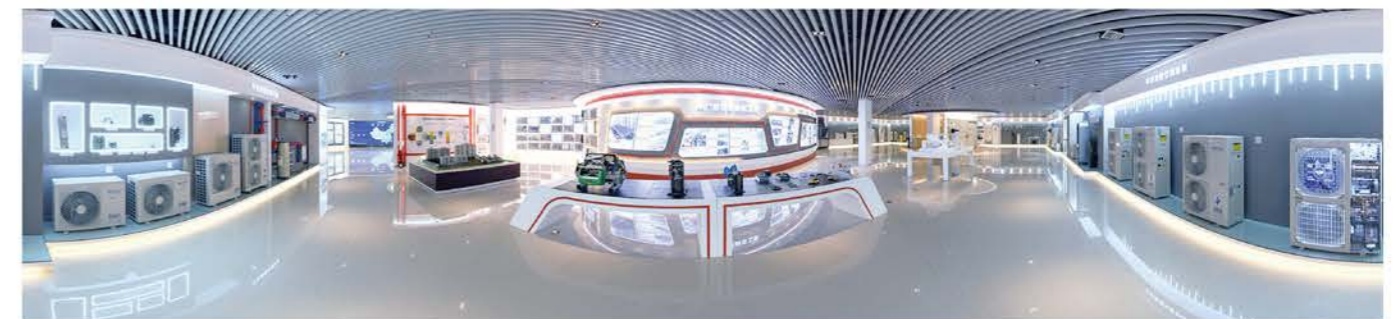



# HISTORY

2022

Transforming from a company to OUTES Group  
Official Air Source Heat Pump Supplier of the 19th Asian Games Hangzhou 2022  
Signed "Great Country Brand" with CCTV

2021

Acquire Kalaoni Ventilation Tech, Established Zhongguang HVAC, Establish Zhongguang Water Purification Tech CO. etc..  
Products were selected into national "Energy Efficiency Star" equipment product catalog  
The domestic market share ranked No.1 of commercial heating brands for 4 consecutive years  
Won Leading Brand in Heat Pump Industry Reward for 9 consecutive years

2020

OUTES Industry Park -Phase III on constructing  
Established OUTES Guangdong R&D Center

2019

OUTES 5C Smart Home sales strategy launch to the market  
OUTES Laboratory Testing Center approved by CNAS, BV, TUV  
Held 11th Distributor Conference  
Annual turnover reached 1.5 Billion Yuan

2018

Launched DC Inverter Cooling&heating heat pump to the market  
No.1 market share in Commercial Heating Heat Pump  
Selected as partner of China High Speed Railway

2017

Launched BLUE SKY DEFENDING PROJECT to promote Air to Water Air Conditioning with floor heating  
Won the bid for 11 North China regional Coal To Electricity Replacement Projects  
Participated in drafting four heat pump industry standards  
Established OUTES Ningbo R&D Center  
Launched Commercial heat pump equipment to the market

2016

Launch into North China heating market  
Won the bid of Coal To Electricity Replacement Project in 6 districts of Beijing  
Launch for overseas market

2015

Established OUTES Shanghai R&D Center

2014

Selected as The Global Strategic Partner by Emerson  
Established The first doctoral workstation in the heat pump industry

2013

OUTES Industry Park -Phase II completed construction  
Won the title of "Leading Enterprises in China low-carbon economy"

2012

Signed as the China Aerospace Enterprise Partner

2011

OUTES Industry Park ( Phase I ) put into production

2010

Organized promotion activities of "thousands miles Vehicle Journey to popularizing Heat Pump"

2009

Initiated the 1st Distributor Summit in Lishui City

2008

Obtained the Heat Pump production license, Obtained ISO9001, ISO14001

2007

Installed first assembly line

2006

OUTES founded

# HONOR



ISO9001



ISO14001



ISO45001



CNAS



BV



TUV



Certificate for Recommended Products of Green & Energy-Saving



A Cooperative Partner of China Space





# Heating · Cooling · Hot Water Heat Pump



## House Heating Heat Pump System

» Cooling ● Heating ● DHW



## » Structure

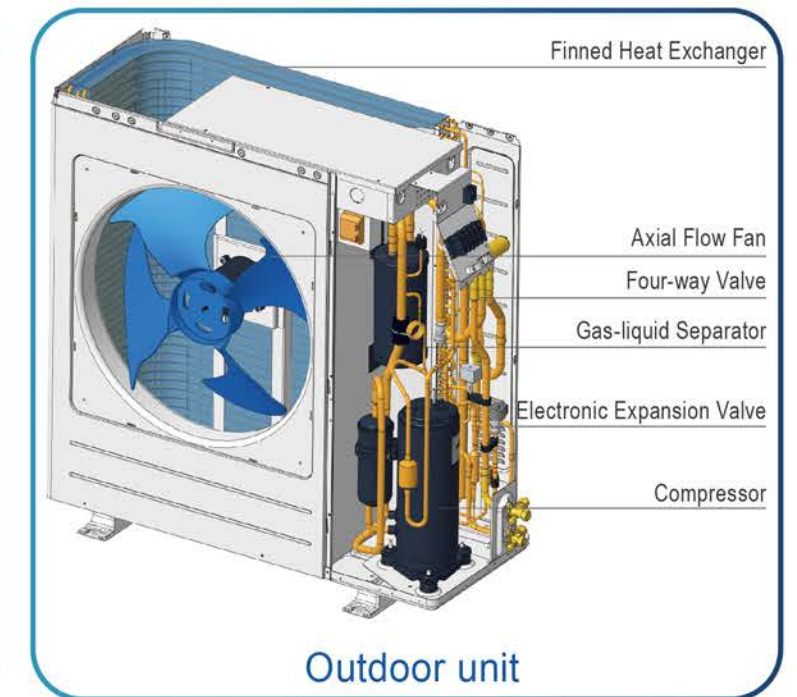
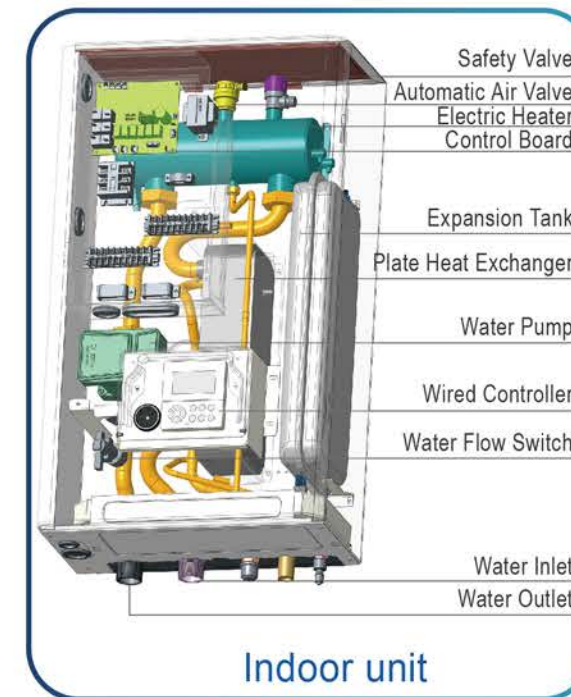

Noted:Reference only



# Split Type-R32



DC INVERTER



Heating • Cooling • DHW

Model		4KW	6KW	8KW	10KW	12KW	14KW	16KW	12KW	14KW	16KW	
Power Supply	/	220V~240V/1N/50Hz	220V~240V/1N/50Hz	220V~240V/1N/50Hz	220V~240V/1N/50Hz	220V~240V/1N/50Hz	220V~240V/1N/50Hz	220V~240V/1N/50Hz	380V~415V/3N/50Hz	380V~415V/3N/50Hz	380V~415V/3N/50Hz	
Heating*	Max. Heating Capacity	kW	4.2	6.4	8.0	10.0	12.1	14.5	15.9	12.1	14.5	15.9
	(A7°C/W35°C) Heating Input Power	kW	0.82	1.28	1.63	2.02	2.44	3.15	3.53	2.44	3.15	3.53
Heating**	Max. Heating Capacity	kW	4.4	6.0	7.5	9.5	11.9	13.8	16.0	11.9	13.8	16.0
	(A7°C/W55°C) Heating Input Power	kW	1.49	2.03	2.36	3.06	3.90	4.68	5.61	3.90	4.68	5.61
Cooling	Max. Cooling Capacity	kW	4.7	7.0	7.45	8.2	11.5	12.4	14.0	11.5	12.4	14.0
	(A35°C/W7°C) Cooling Input Power	kW	1.3	2.25	2.22	2.52	4.18	4.96	5.60	4.18	4.96	5.60
Outdoor Unit	Compressor	/	Twin Rotary	Twin Rotary	Twin Rotary	Twin Rotary	Twin Rotary	Twin Rotary	Twin Rotary	Twin Rotary	Twin Rotary	Twin Rotary
	Noise(Sound Power Level)	dB(A)	≤56	≤58	≤59	≤60	≤64	≤65	≤68	≤64	≤65	≤68
	Net Weight	kg	62	62	78	78	95	95	95	105	105	105
	Net Dimension(L×W×H)	mm	1045×405×770	1045×405×770	995×390×1015	995×390×1015	995×390×1015	995×390×1015	995×390×1015	995×390×1015	995×390×1015	995×390×1015
	Packing Dimension(L×W×H)	mm	1170×520×890	1170×520×890	1145×510×1160	1145×510×1160	1145×510×1160	1145×510×1160	1145×510×1160	1145×510×1160	1145×510×1160	1145×510×1160
Indoor Unit	Heat Exchanger	/	Plate	Plate	Plate	Plate	Plate	Plate	Plate	Plate	Plate	Plate
	Electric Heater	kW	3	3	3	3	3	3	3	9	9	9
	Rated Water Flow	m <sup>3</sup> /h	0.72	1.1	1.38	1.72	2.08	2.49	2.73	2.08	2.49	2.73
	Noise(Sound Power Level)	dB(A)	≤40	≤40	≤42	≤42	≤43	≤43	≤43	≤43	≤43	≤43
	Net Weight	kg	41	41	42	42	43	43	43	45	45	45
	Net Dimension(L×W×H)	mm	470×790×270	470×790×270	470×790×270	470×790×270	470×790×270	470×790×270	470×790×270	470×790×270	470×790×270	470×790×270
	Packing Dimension(L×W×H)	mm	550×960×340	550×960×340	550×960×340	550×960×340	550×960×340	550×960×340	550×960×340	550×960×340	550×960×340	550×960×340
Max. Water Outlet Temperature	°C	60	60	60	60	60	60	60	60	60	60	
Range of Working Operation	°C	-25~46	-25~46	-25~46	-25~46	-25~46	-25~46	-25~46	-25~46	-25~46	-25~46	
Refrigerant	/	R32	R32	R32	R32	R32	R32	R32	R32	R32	R32	
ERP Level (35°C)	/	A+++	A+++	A+++	A+++	A+++	A+++	A+++	A+++	A+++	A+++	
ERP Level (55°C)	/	A++	A++	A++	A++	A++	A++	A++	A++	A++	A++	
Container Loading (20'/40'H)	Sets	44/92/104	44/92/104	44/92/104	34/74/75	34/74/75	34/74/75	34/74/75	34/74/75	34/74/75	34/74/75	

Remark:  
 1. Testing Condition: Heating\*: Ambient Temp.(DB/WB):7°C/6°C, Water Temp.(In/Out):30°C/35°C.  
 Heating\*\*: Ambient Temp.(DB/WB):7°C/6°C, Water Temp.(In/Out):47°C/55°C.  
 Cooling: Ambient Temp.(DB/WB):35°C/24°C, Water Temp.(In/Out):12°C/7°C.  
 2. The above data test reference EN14825:2016, EN14511:2011, EN12102:2008, (EU) No 811:2013, (EU) No 813:2013.  
 3. The data above is only for reference, and might be changed without prior notice.



# Heating · Cooling · Hot Water Heat Pump



## Split Heating · Cooling · Hot Water Heat Pump

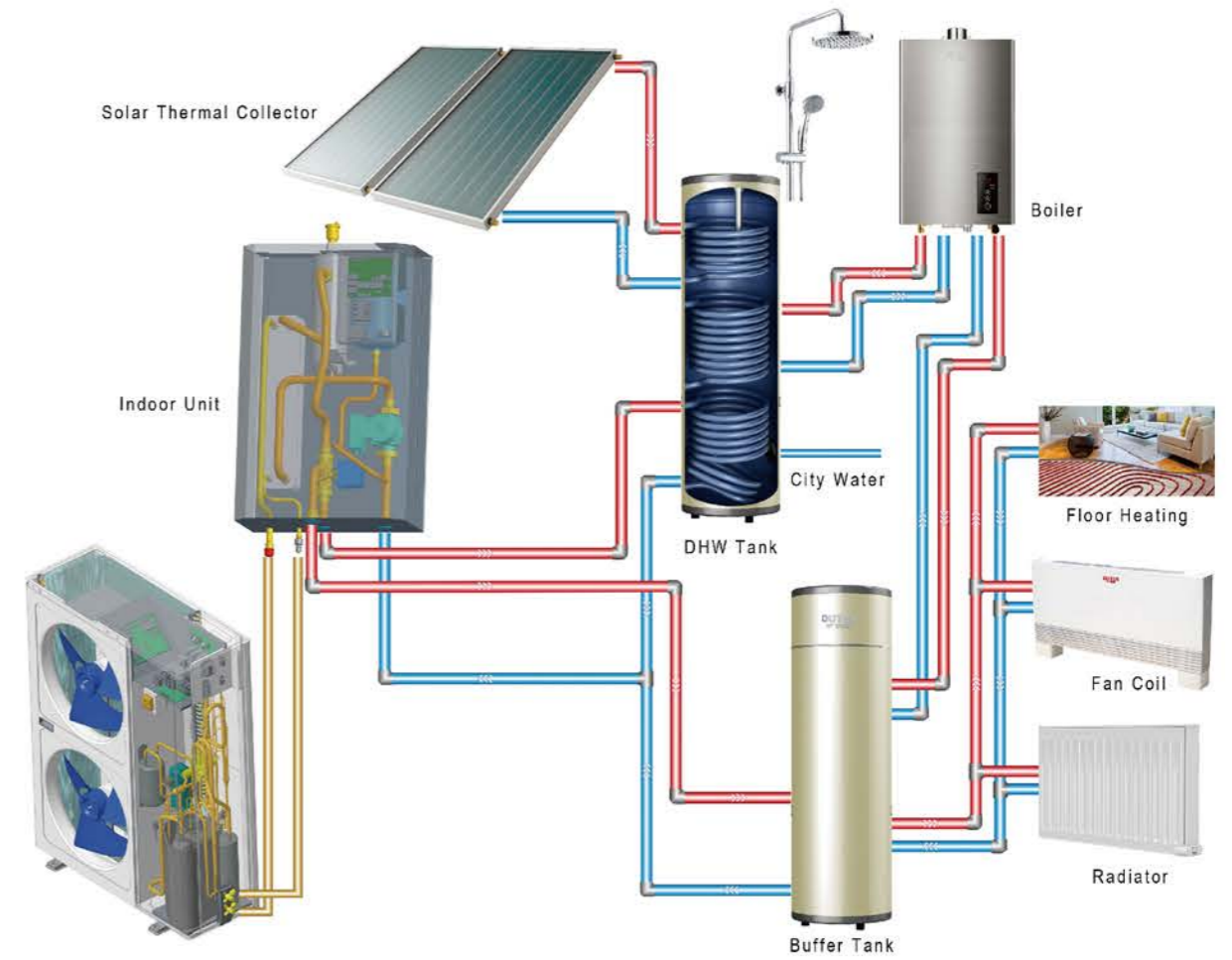

### Indoor Unit

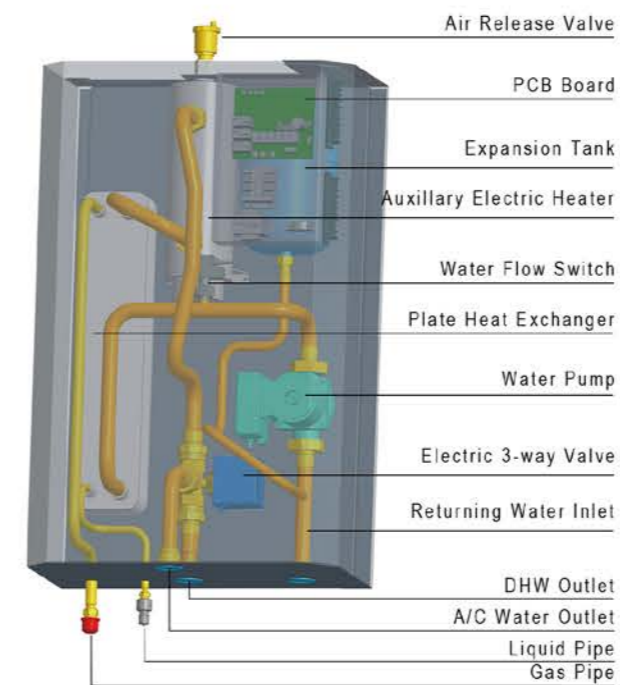

### Outdoor Unit

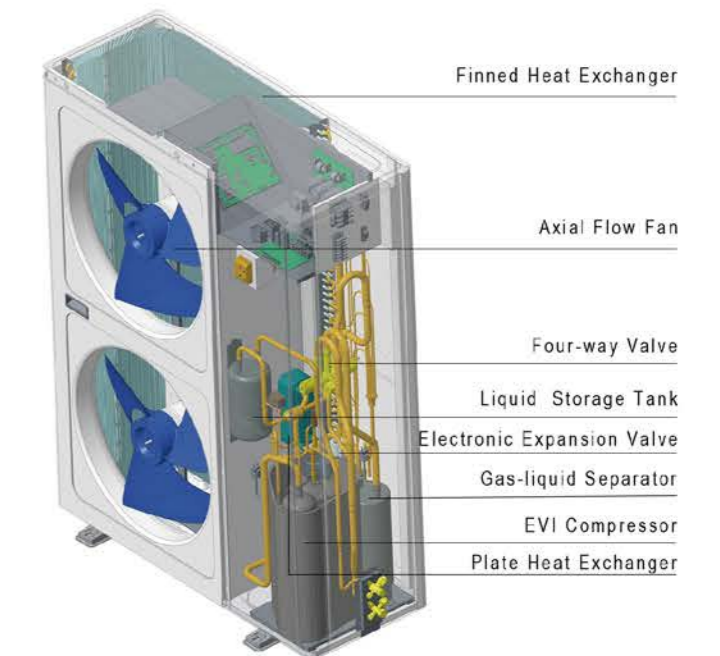

Note: Reference only



# Split Type-DC Inverter

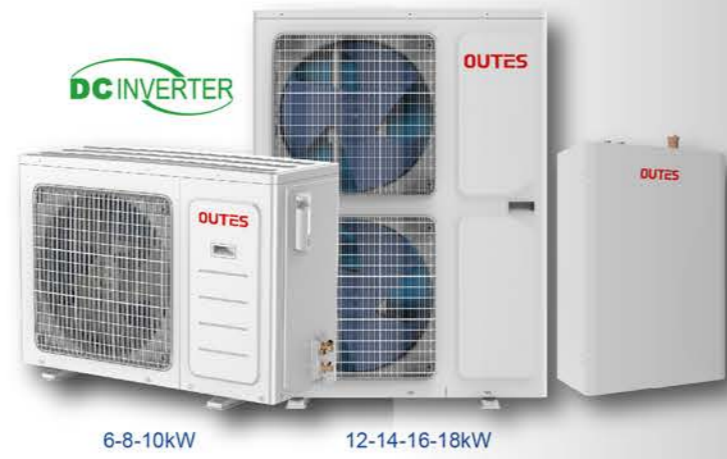
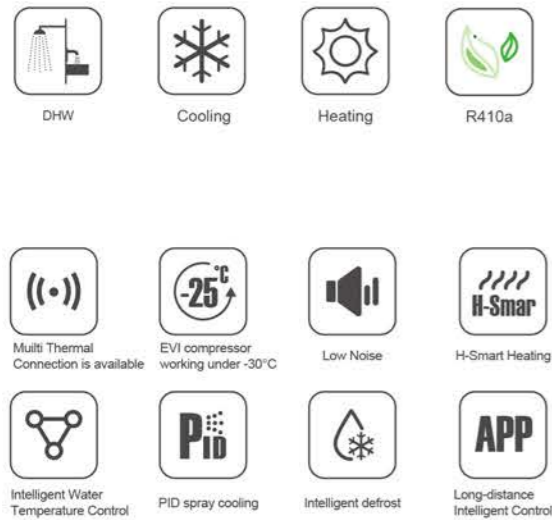

Model		AHbS06D/IOP	AHbS08D/IOP	AHbS10D/IOP	AHbS12D/IOP	AHbS14D/IOP	AHbS16D/IOP	AHbS16D/IOP
Power Supply		220V-240V/50Hz	220V-240V/50Hz	220V-240V/50Hz	220V-240V/50Hz	220V-240V/50Hz	220V-240V/50Hz	220V-240V/50Hz
Heating* (A7°C/W35°C)	Max. Heating Capacity	kW 6.0	8.0	10.0	12.0	14.0	16.0	17.5
	Heating Input Power	kW 1.48	2.02	2.43	2.73	3.33	3.95	4.43
	Heating Capacity Min./Max.	kW 2.4/6	3.2/8	4.2/10	5.0/12	5.4/14	6.3/16	7.3/17.5
Cooling (A35°C/W7°C)	Max. Cooling Capacity	kW 4.5	6.0	7.5	9.0	10.0	12.0	14.0
	Cooling Input Power	kW 1.48	2.32	2.90	3.25	3.80	4.60	5.76
	Cooling Capacity Min./Max.	kW 1.8/4.5	2.4/6.0	3/7.5	3.6/9	4.1/10	5.1/12	5.8/14
Outdoor Unit	Compressor	/ Twin Rotary	Twin Rotary	Twin Rotary	Twin Rotary	Twin Rotary	Twin Rotary	Twin Rotary
	Noise	dB(A) ≤58	≤60	≤60	≤58	≤58	≤60	≤60
	Net Weight	kg 64	75	75	127	127	132	132
	Net Dimension(L×W×H)	mm 1090×485×770	1090×485×770	1090×485×770	1095×485×1410	1095×485×1410	1095×485×1410	1095×485×1410
	Packing Dimension(L×W×H)	mm 1167×517×820	1167×517×820	1167×517×820	1134×500×1550	1134×500×1550	1134×500×1550	1134×500×1550
Indoor Unit	Heat Exchanger	/ Plate	Plate	Plate	Plate	Plate	Plate	Plate
	Water Pump Brand	/ Grundfos	Grundfos	Grundfos	Grundfos	Grundfos	Grundfos	Grundfos
	Rated Water Flow	m³/h 1.03	1.38	1.72	2.06	2.41	2.75	3.01
	Electric Heater	kW 3	3	3	3	3	3	3
	Noise	dB(A) ≤35	≤35	≤35	≤35	≤35	≤35	≤35
	Net Weight	kg 45	45	45	45	45	45	45
	Net Dimension(L×W×H)	mm 1015×527×297	1015×527×297	1015×527×297	1015×527×297	1015×527×297	1015×527×297	1015×527×297
	Packing Dimension(L×W×H)	mm 1182×620×360	1182×620×360	1182×620×360	1182×620×360	1182×620×360	1182×620×360	1182×620×360
	Max. Water Outlet Temperature	°C 55	55	55	55	55	55	55
Range of Working Operation	°C -25~43	-25~43	-25~43	-25~43	-25~43	-25~43	-25~43	
Refrigerant	/ R410A	R410A	R410A	R410A	R410A	R410A	R410A	
SCOP	WW 4.0	4.05	3.9	4.07	4.05	3.95	4.26	
ERP Level (35°C)								
Container Loading (20'/40'H)	Sets	54/162	54/162	54/162	27/54	27/54	27/54	27/54

Remark:  
 1. Test conditions: Heating\*: Ambient Temp.(DB/WB):7°C/6°C, Water Temp.(In/Out):30°C/35°C.  
 2. The above data test reference EN14825:2016  
 3. The data above is only for reference, and might be changed without prior notice.

# Monoblock Heating · Cooling · Hot Water Heat Pump

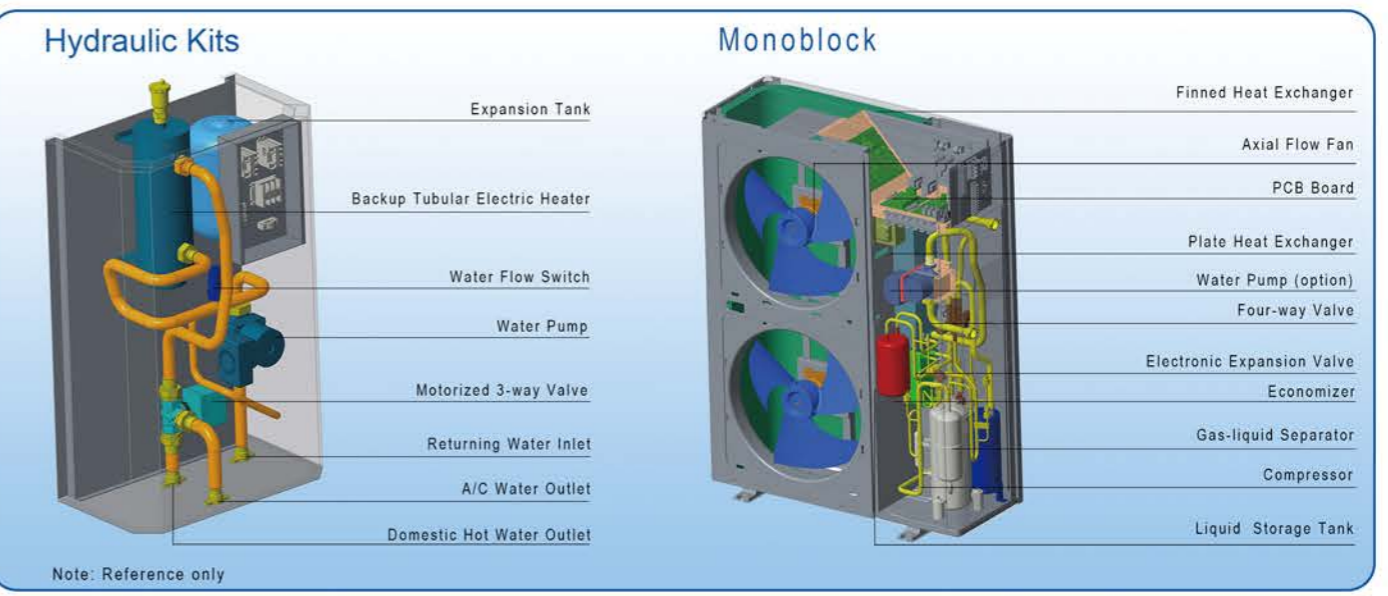
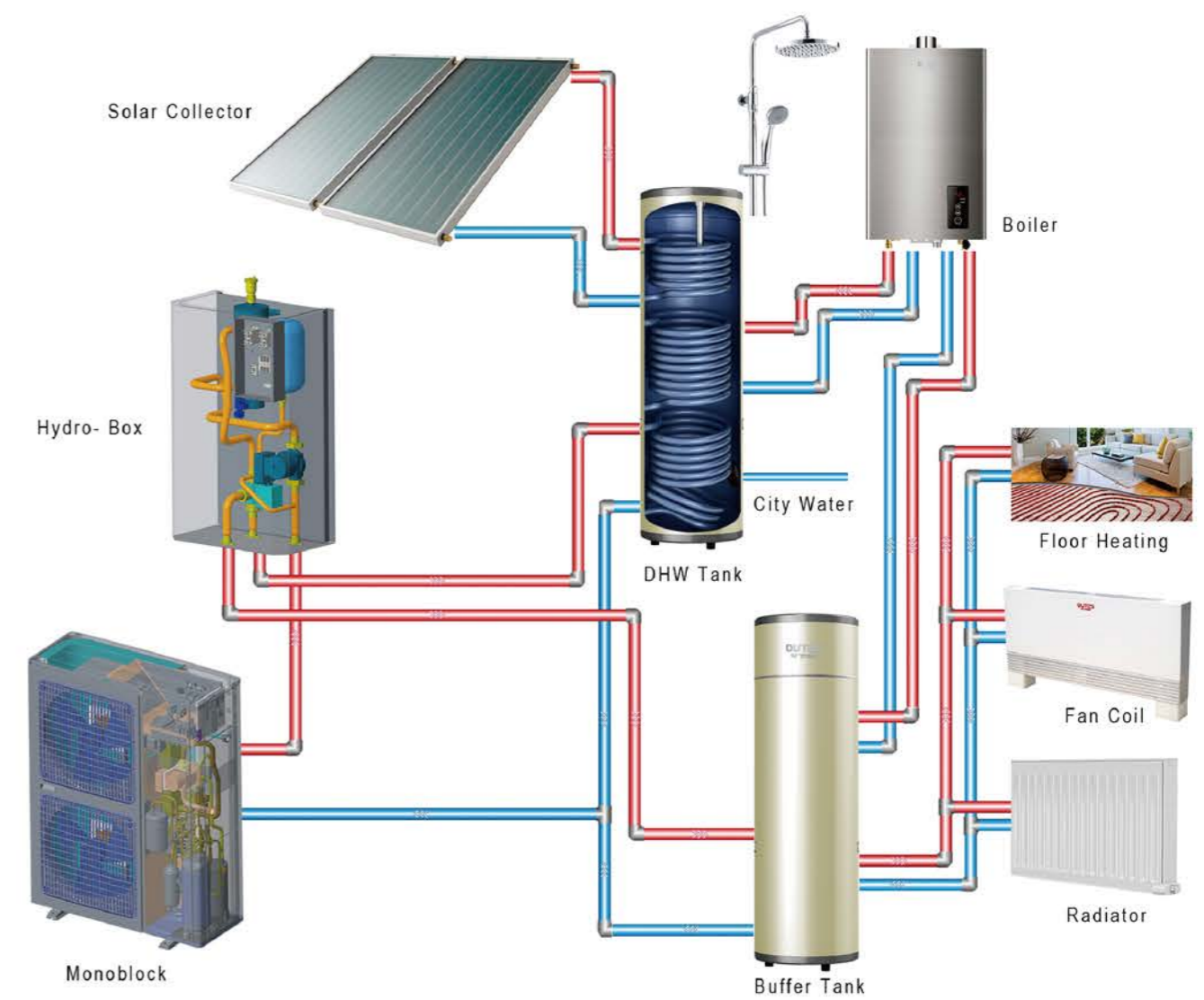

Note: Reference only



# Monoblock-DC Inverter

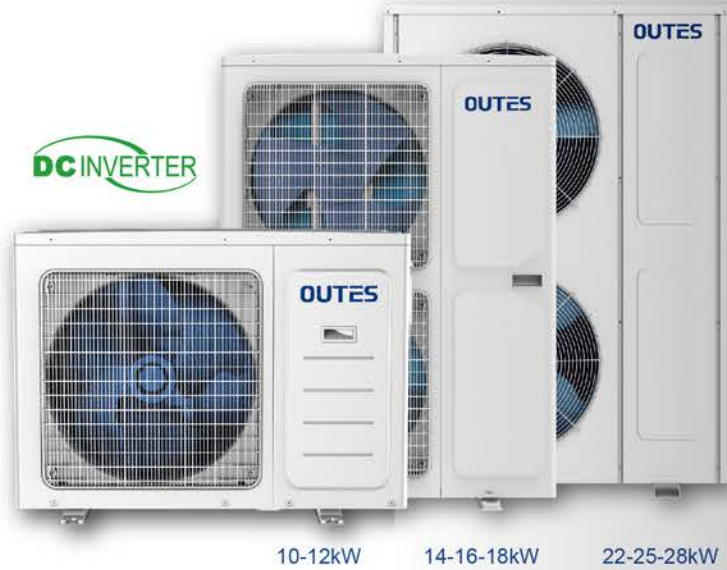

Model	/	AHb10D	AHb12D	AHb14D	AHb16D	AHb18D	AHb22De	AHb25De	AHb28De	
Power Supply	/	220V~240V/50Hz	220V~240V/50Hz	220V~240V/50Hz	220V~240V/50Hz	220V~240V/50Hz	380V~415V/50Hz	380V~415V/50Hz	380V~415V/50Hz	
Heating* (A7 C/W35 C)	Max. Heating Capacity	kW	10.0	12.0	14.0	16.0	17.5	22.00	25.00	28.00
	Heating Input Power	kW	2.48	2.73	3.33	3.95	4.43	5.30	6.10	6.90
	Heating Capacity Min./Max.	kW	4.2/10	5.0/12	5.4/14	6.4/16	7.17/17.5	8.5/22	9.5/25	10.5/28
Cooling (A35 C/W7 C)	Max. Cooling Capacity	kW	7.0	9.0	10.0	12.0	14.0	20.0	22.0	25.0
	Cooling Input Power	kW	2.80	3.05	3.50	4.60	5.76	6.00	6.90	8.00
	Cooling Capacity Min./Max.	kW	2.92/7	3.6/9	4.11/10	5.1/12	5.8/14	6.3/10.3	6.9/11.2	7.5/12.5
Refrigerant	/	R410A	R410A	R410A	R410A	R410A	R410A	R410A	R410A	
Max. Water Outlet Temperature	°C	55 C	55 C	55 C	55 C	55 C	55 C	55 C	55 C	
Range of Working Operation	°C	-25~43	-25~43	-25~43	-25~43	-25~43	-25~43	-25~43	-25~43	
Compressor(Brand/Type)	/	GMCC/Rotary	GMCC/Rotary	GMCC/Rotary	GMCC/Rotary	GMCC/Rotary	Panasonic/Rotary	Panasonic/Rotary	Panasonic/Rotary	
Heat Exchanger	Type	Plate	Plate	Plate	Plate	Plate	Plate	Plate	Plate	
Rated Water Flow	m³/h	1.72	2.06	2.41	2.75	3.01	3.40	3.80	4.30	
ERP Level(35 C)	/	A++	A++	A++	A++	A++	A++	A++	A++	
Noise	dB(A)	60	60	60	62	62	63	63	63	
Net Weight	kg	85	85	150	160	160	185	185	185	
Net Dimension(L×W×H)	mm	1036×406×740	1036×406×740	1036×406×1410	1036×406×1410	1036×406×1410	1110×420×1560	1110×420×1560	1110×420×1560	
Packing Dimension(L×W×H)	mm	1086×446×820	1086×446×820	1086×446×1490	1086×446×1490	1086×446×1490	1150×520×1720	1150×520×1720	1150×520×1720	
Loading Quantity(20'/40'/40H)	Sets	54/108/162	54/108/162	27/54/54	27/54/54	27/54/54	24/48/48	24/48/48	24/48/48	

Hydro Box	Model	/	AHb10D/HP	AHb12D/HP	AHb14D/HP	AHb16D/HP	AHb18D/HP
	Water Proof Class	/	IPX0	IPX0	IPX0	IPX0	IPX0
	Circulation Water Pump	Head(M)	8	8	8	8	8
		Brand	Grundfos	Grundfos	Grundfos	Grundfos	Grundfos
	Electric Heater	kW	3	3	3	3	3
	Net Weight	kg	35	35	35	35	35
	Net Dimension(L×W×H)	mm	837×515×287	837×515×287	837×515×287	837×515×287	837×515×287
Packing Dimension(L×W×H)	mm	1080×594×351	1080×594×351	1080×594×351	1080×594×351	1080×594×351	

Hydro Box Including 3kW Electric Heater, Water Pump, Three Way Valves, Controller, Expansion Tank, Discharge Valve

Remark:  
 1. Test conditions: The above data test reference EN14825:2016  
 ① Heating\*: Ambient Temp.(DB/WB):7 C/6 C, Water Temp.(In/Out):30 C/35 C. ② Heating\*\*: Ambient Temp.(DB/WB):7 C/6 C, Water Temp.(In/Out):40 C/45 C.  
 ③ Heating\*\*\*: Ambient Temp.(DB/WB):2 C/1 C, Water Temp.(In/Out):25 C/30 C. ④ Cooling: Ambient Temp.(DB/WB):35 C/24 C, Water Temp.(In/Out):12 C/7 C.  
 2. The data above is only for reference, and might be changed without prior notice.

# Monoblock-ON/OFF



Model	/	AHb09E	AHb15E	AHb19E	
Power Supply	/	220-240V/1N/50Hz	220-240V/1N/50Hz	220-240V/1N/50Hz	
Heating (A7 C/W35 C)	Rated Heating Capacity	kW	8.5	14.5	18.5
	Heated Input Power	kW	2.15	3.69	4.64
Cooling (A35 C/W7 C)	Rating Cooling Capacity	kW	6.7	10	13.4
	Cooling Input Power	kW	2.6	4.1	5.2
Hot Water (A20 C/W55 C)	Rated Heating Capacity	kW	10.2	17.4	22.4
	Water Yield	L/H	220	375	482
	Rated Input Power	kW	2.25	3.96	4.85
	Rated Input Power	kW	3.4	5.9	6.9
	Ambient Temperature	°C	-25~49	-25~49	-25~49
	Refrigerant	/	R410A	R410A	R410A
	Max. Water Outlet Temp.	°C	55	55	55
	Compressor Brand	/	Copeland/Scroll	Copeland/Scroll	Copeland/Scroll
	Compressor Type	/	ON/OFF	ON/OFF	ON/OFF
	Water Side Heat Exchanger	/	Plate	Plate	Plate
Outdoor Unit	Rated Water Flow	m³/h	1.46	2.49	3.18
	Noise	dB(A)	≤60	≤62	≤63
	SCOP	W/W	3.5	3.57	3.69
	ERP Level (35 C)	/	A+	A+	A+
	Net Weight	kg	100	150	160
	Net Dimensions(L×W×H)	mm	1036×406×740	1036×406×1410	1036×406×1410
	Packing Dimensions(L×W×H)	mm	1086×446×820	1086×446×1490	1086×446×1490
	Container Loading(20'/40'/40H)	Sets	54/108/162	27/54/54	27/54/54

Hydro Box	Model	/	AHb09E/HP	AHb15E/HP	AHb19E/HP
	Water Proof Class	/	IPX0	IPX0	IPX0
	Net Weight	kg	35	35	35
	Net Dimension(L×W×H)	mm	960×530×300	960×530×300	960×530×300
	Packing Dimensions(L×W×H)	mm	1190×625×350	1190×625×350	1190×625×350
	Hydraulic Box Including 3kW Electric Heater, Water Pump, Three Way Valves, Controller, Expansion Tank, Discharge Valve				

Remark:  
 1. Test conditions: The above data test reference EN14825:2016  
 ① Heating\*: Ambient Temp.(DB/WB):7 C/6 C, Water Temp.(In/Out):30 C/35 C.  
 ② Heating\*\*: Ambient Temp.(DB/WB):7 C/6 C, Water Temp.(In/Out):40 C/45 C.  
 ③ Hot Water Capacity Rating: Ambient Temp.(DB/WB):20 C/15 C, Water Temp.(Initial/Terminal):15 C/55 C  
 2. The data above is only for reference, and might be changed without prior notice.



# OUTES

## All In One Heat Pump Water Heater



 R134a



### Features



- Enamel Water Tank
- 50mm Foaming Insulation Material
- External Aluminium Micro-channel Coil
- 2kW Auxiliary Electric Heater Back Up for Cold Winter
- Built-in Magnesium Rod & Anion Anode for Anti-corrosion
- Built-in Internal Solar Water Coil or Boiler Water Coil are Optional for Multi-thermal Connection



Hot Water



# Structure

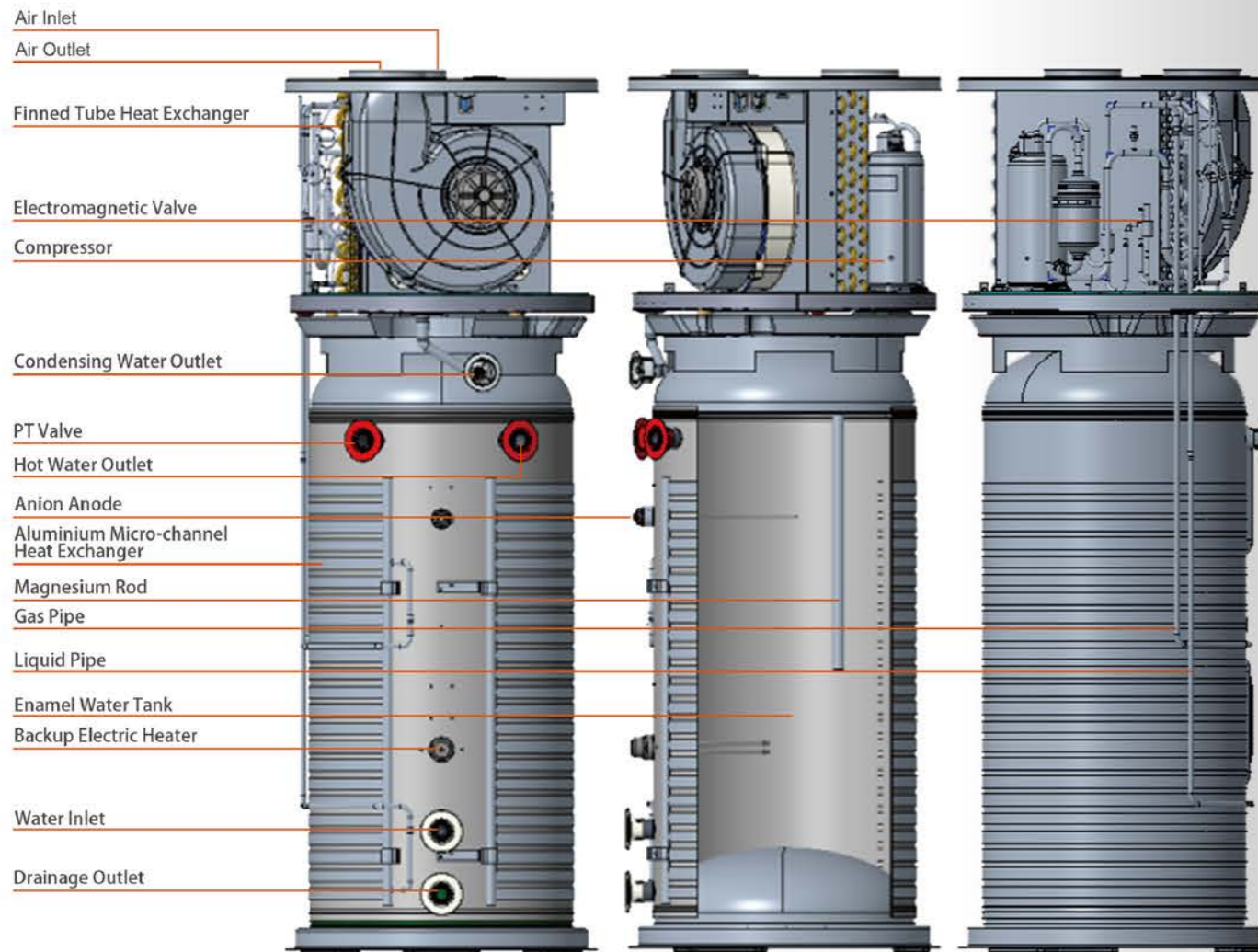
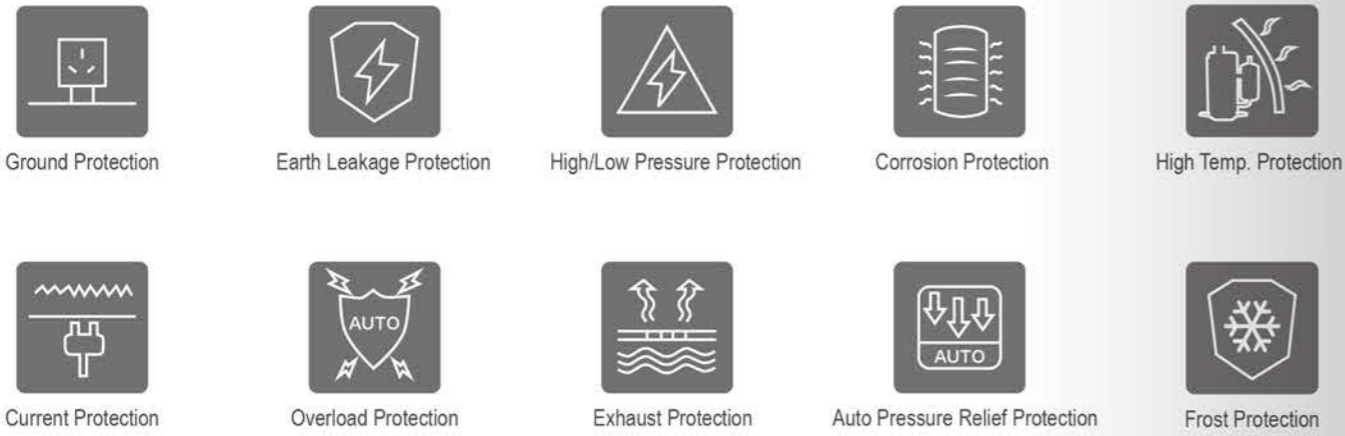

# MODEL A



Hot Water

Model	/	AAa21R1/160E	AAa21R1/160E	AAa21R1/160E	AAa21R1/160E
Water Tank Volume	L	160	200	2260	300
Applicable Persons	/	3	4	5	6
Hot Water Yield	L/h	46	46	46	46
Power Supply	V/Ph/Hz	220~240V/1/50Hz	220~240V/1/50Hz	220~240V/1/50Hz	220~240V/1/50Hz
Heating Capacity (Heat Pump)	W	2100	2100	2100	2100
Heating Input Power (Heat Pump)	W	535	535	535	535
Backup Electric Heater	kW	2	2	2	2
Noise	dB(A)	≤57	≤57	≤57	≤57
Refrigerant	/	R134A			
Compressor	/	GMCC/Rotary			
Water Side Heat Exchanger	/	Aluminium Micro-Channel			
Water Outlet Temp. (Default/Max.)	°C	55 (Heat Pump) Max.75 (HP+E-Heater)			
Running Ambient Temp.	°C	-20~46 (Heat Pump+E-Heater), -7~46 (Heat Pump)			
COPDHW(EN16147)	WW	/	3.16	2.84	3.39
ErP Class	/	/			
Net Weight/Gross Weight	kg	89/99	103/115	113/126	121/136
Packing Dimension(LxWxH)	mm	725x725x1705	725x725x1910	750x720x2075	750x720x2240
Container Loading (20'/40')	Sets	24/48	24/48	24/48	24/48

Remark:  
 1. Test conditions: Base on EN16147:2017. Ambient Temp.(DB/WB):20°C/15°C, Water Temp.(In/Out):15°C/55°C;  
 2. The above data may be changed without prior notice for product improvement.



## MODEL B



## MODEL C



Model	/	AAb21R1/200E	AAb21R1/300E
Water Tank Volume	L	200	300
Applicable Persons	/	4	6
Hot Water Yield	L/h	46	46
Power Supply	V/Ph/Hz	220~240V/1/50Hz	220~240V/1/50Hz
Heating Capacity (Heat Pump)	W	2100	2100
Heating Input Power (Heat Pump)	W	535	535
Backup Electric Heater	kW	2	2
Noise	dB(A)	≤40	≤40
Refrigerant	/	R134A	
Compressor	/	GMCC/Rotary	
Water Side Heat Exchanger	/	Aluminium Micro-Channel	
Water Outlet Temp. (Default/Max.)	°C	55 (Heat Pump) Max.75 (HP+E-heater)	
Running Ambient Temp.	°C	-20~46 (Heat Pump+E-Heater),-7~46 (Heat Pump)	
COPDHW(EN16147)	W/W	3.39	3.47
ErP Class	/		
Net Weight/Gross Weight	kg	120/130	130/140
Packing Dimension(LxWxH)	mm	725x725x1910	740x740x2125
Container Loading (20'/40')	Sets	24/48	24/48

Remark:  
 1. Test conditions:Base on EN16147:2017. Ambient Temp.(DB/WB):20°C/15°C, Water Temp.(In/Out):15°C/55°C;  
 2. The above data may be changed without prior notice for product improvement.

Model	/	AAc17R1/120E	AAc17R1/160E	AAc17R1/180E
Water Tank Volume	L	120	160	180
Applicable Persons	/	2	3	4
Hot Water Yield	L/h	37	37	37
Power Supply	V/Ph/Hz	220~240V/1/50Hz	220~240V/1/50Hz	220~240V/1/50Hz
Heating Capacity (Heat Pump)	W	1700	1700	1700
Heating Input Power (Heat Pump)	W	410	410	410
Backup Electric Heater	kW	2	2	2
Noise	dB(A)	≤48	≤48	≤48
Refrigerant	/	R134A		
Compressor	/	Panasonic/Rotary		
Water Side Heat Exchanger	/	Aluminium Micro-Channel		
Water Outlet Temp. (Default/Max.)	°C	55 (Heat Pump) Max.75 (HP+E-heater)		
Running Ambient Temp.	°C	-20~46 (Heat Pump+Electric Heater),-7~46 (Heat Pump)		
COPDHW(EN16147)	W/W	3.39	3.47	3.11
ErP Class	/	/	/	
Net Weight/Gross Weight	kg	74/84	97/107	102/112
Packing Dimension(LxWxH)	mm	626x626x1510	626x626x1705	626x626x1850
Container Loading (20'/40')	Sets	40/80	40/80	40/80

Remark:  
 1. Test conditions:Base on EN16147:2017. Ambient Temp.(DB/WB):20°C/15°C, Water Temp.(In/Out):15°C/55°C;  
 2. The above data may be changed without prior notice for product improvement.



# Top Part Heat Pump Water Heater

with water pump



Supplying Domestic Sanitary Hot Water for bath, shower, washing hand, House Cleaning, Spa, Kitchen.



## Structure

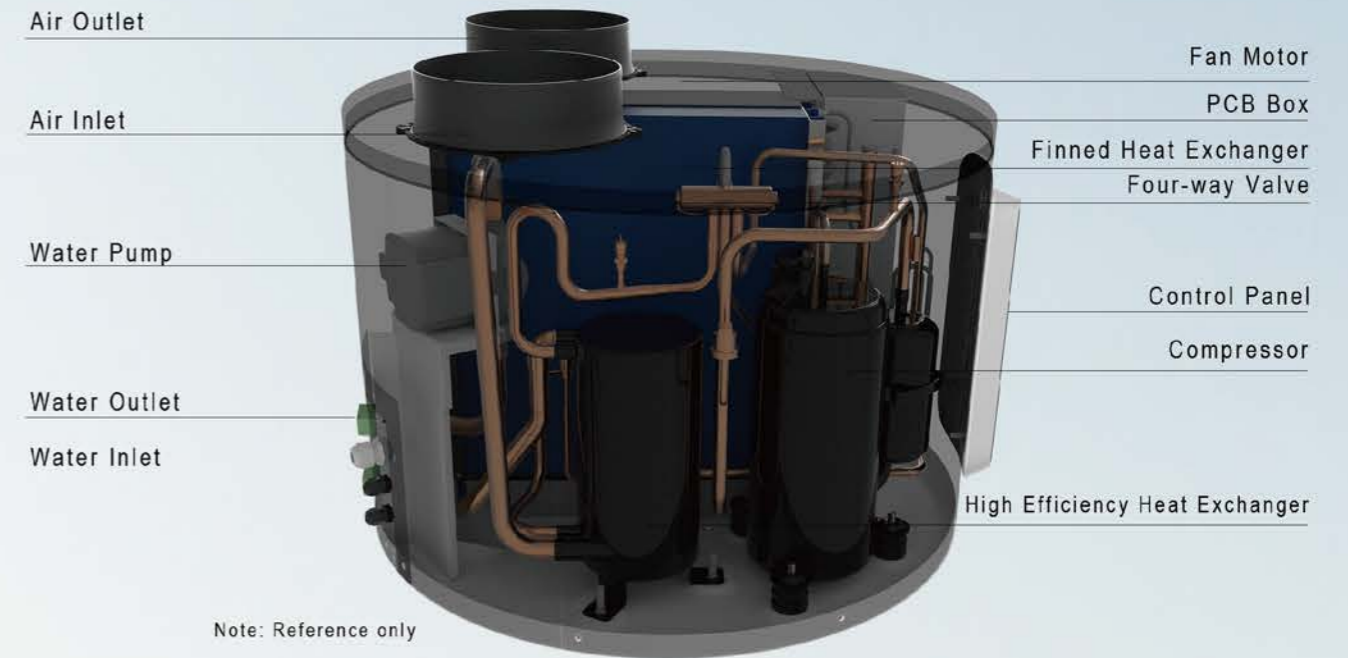

Note: Reference only

Model	/	ATb34R1P
Power Supply	/	220~240V/50Hz
Heating Capacity	W	3400
Rated Input Power	W	866
COP	W/W	4
Rated Water Output	L/h	64
Max Temp.	°C	65
Sound Power Level	dB(A)	≤57
Refrigerant	/	R134A
Compressor	/	GMCC/Rotary
Max. Air Exhaust/Absorb Working Pressure	MPa/MPa	2.6/1.3
Working Condition	°C	-7°C~46°C (Heat Pump, no Tank)
	°C	-20°C~46°C (Heat Pump+E-Heater with Tank), -7°C~46°C (Heat Pump)
Tapping Cycle	/	XL
COP <sub>DHW</sub> (EN16147)	W/W	2.87
ErP Class	/	
Net Weight	kg	63
Gross Weight	kg	68
Net Dimension	mm	Φ650×534
Packing Dimension(L×W×H)	mm	750×720×621
Container Loading (20'/40')	Sets	69 /138

Built-in Grundfos water pump (optional)

Remark:

1. Test conditions: Base on EN16147:2017. Ambient Temp.(DB/WB): 20°C/15°C, Water Temp.(In/Out): 15°C/55°C;
2. The above data may be changed without prior notice for product improvement.



# Monoblock Heat Pump Water Heater

with water pump



## Structure

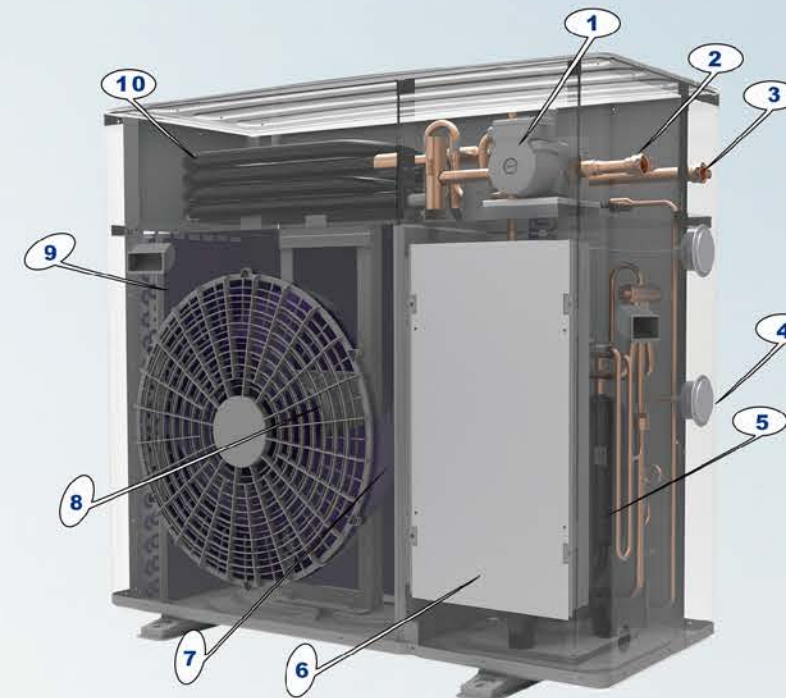

- ① Water Pump
- ② Water Inlet
- ③ Water Outlet
- ④ Pressure Gage
- ⑤ Compressor
- ⑥ PCB Box
- ⑦ Axial Flow Fan
- ⑧ Fan Motor
- ⑨ Finned Heat Exchanger
- ⑩ Tube-in Tube heat exchanger

Note: Reference only

Model	/	AWC4P	AWC5P	AWC7P	AWC10P
Power Supply	V/Ph/Hz	220~240V/1/50Hz	220~240V/1/50Hz	220~240V/1/50Hz	220~240V/1/50Hz
Hot Water Yield	L/h	75	108	140	209
Water Outlet Temp. (Default/Max.)	°C	55/60	55/60	55/60	55/60
Running Ambient Temp.	°C	-7-46	-7-46	-7-46	-7-46
Rating Heating Capacity	kW	3.5	5.0	6.5	9.7
Heating Input Power	kW	0.85	1.20	1.58	2.34
Heating Input Current	A	7.7	10.1	14.0	19.8
Noise	dB(A)	≤54	≤54	≤54	≤57
Compressor	/	GMCC/Rotary	GMCC/Rotary	GMCC/Rotary	GMCC/Rotary
Water Side Heat Exchanger	/	Tube in tube	Tube in tube	Tube in tube	Tube in tube
Throttling Type	/	EEV	EEV	EEV	EEV
Refrigerant	/	R410A	R410A	R410A	R410A
Fan Motor	/	AC Motor	AC Motor	AC Motor	AC Motor
Water Pump	/	Grundfos	Grundfos	Grundfos	Grundfos
Water Connection Size(Inner Thread)	Inch	3/4"	3/4"	3/4"	3/4"
Net Weight	kg	54	54	63	96
Gross Weight	kg	57	57	67	119
Net Dimension(W×D×H)	mm	790×285×780	790×285×780	790×285×700	1036×406×950
Packing Dimension(W×D×H)	mm	925×410×835	925×410×835	925×410×755	1073×450×1099
Container Loading (20'/40')	Unit	68/213	68/213	96/213	52/108

Built-in Grundfos water pump (optional)

Remark:

1. Test conditions: Base on EN16147:2017. Ambient Temp.(DB/WB):20°C/15°C, Water Temp.(In/Out):15°C/55°C;
2. The above data may be changed without prior notice for product improvement.

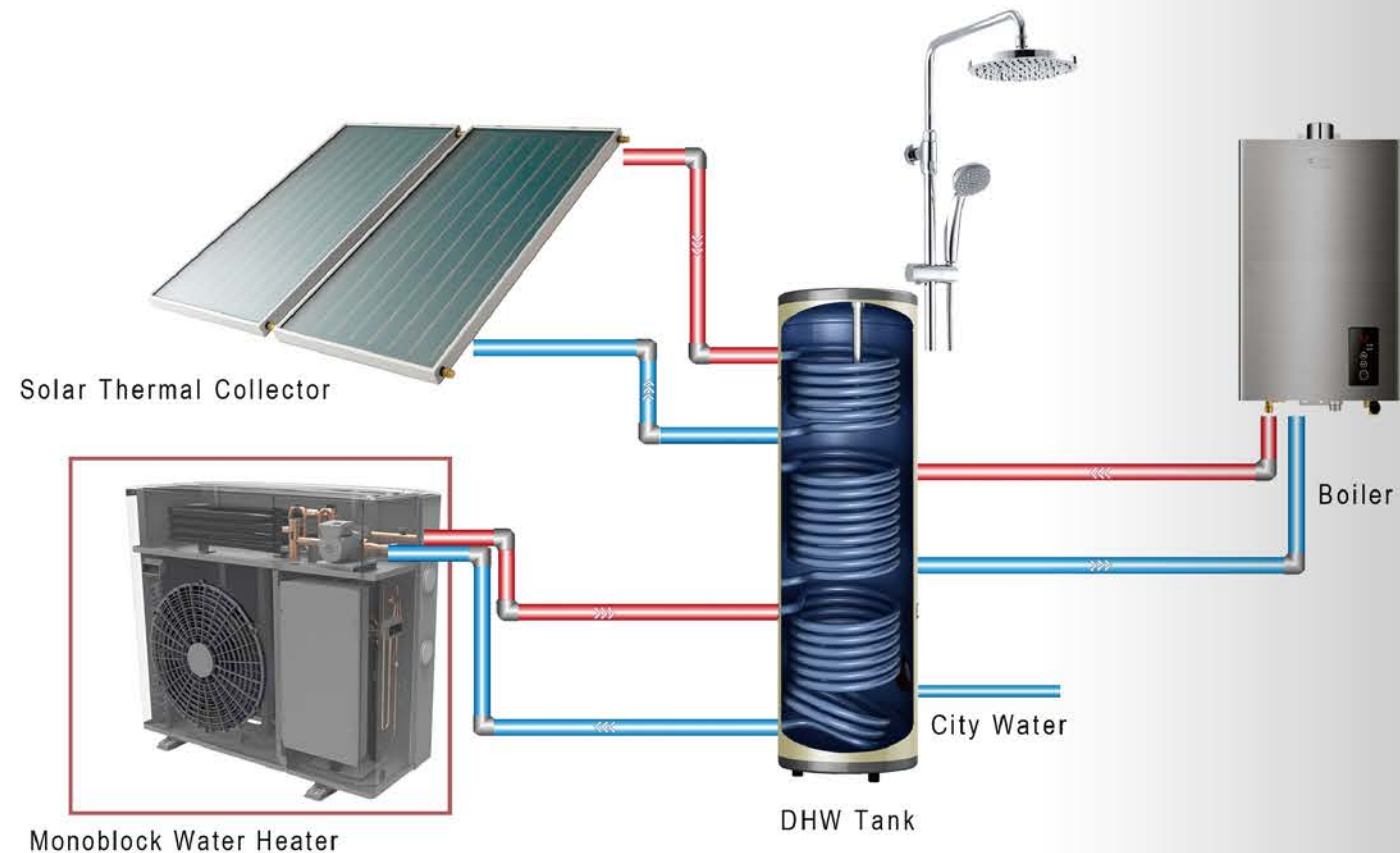



# Split Type Heat Pump Water Heater

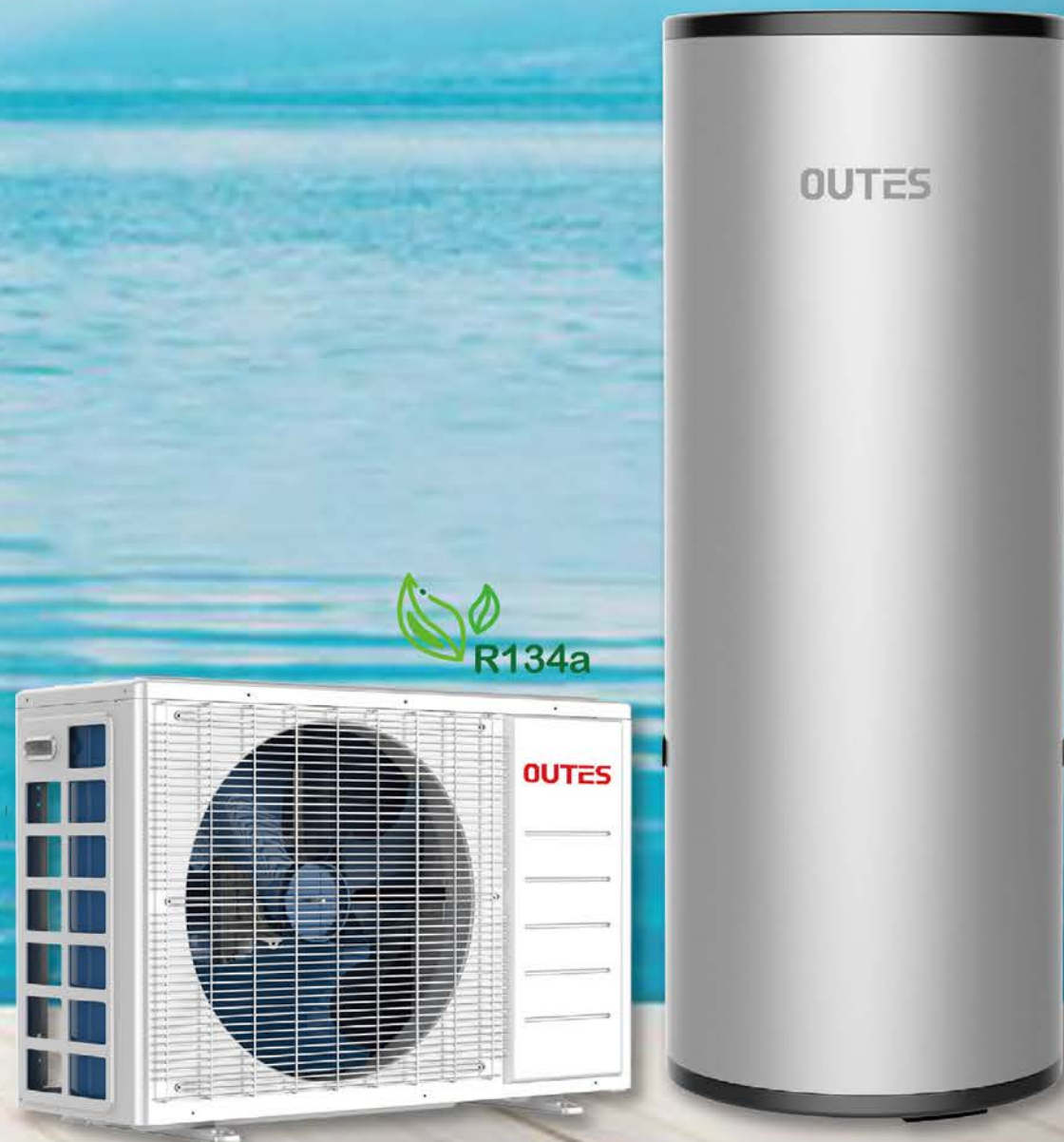

## Structure

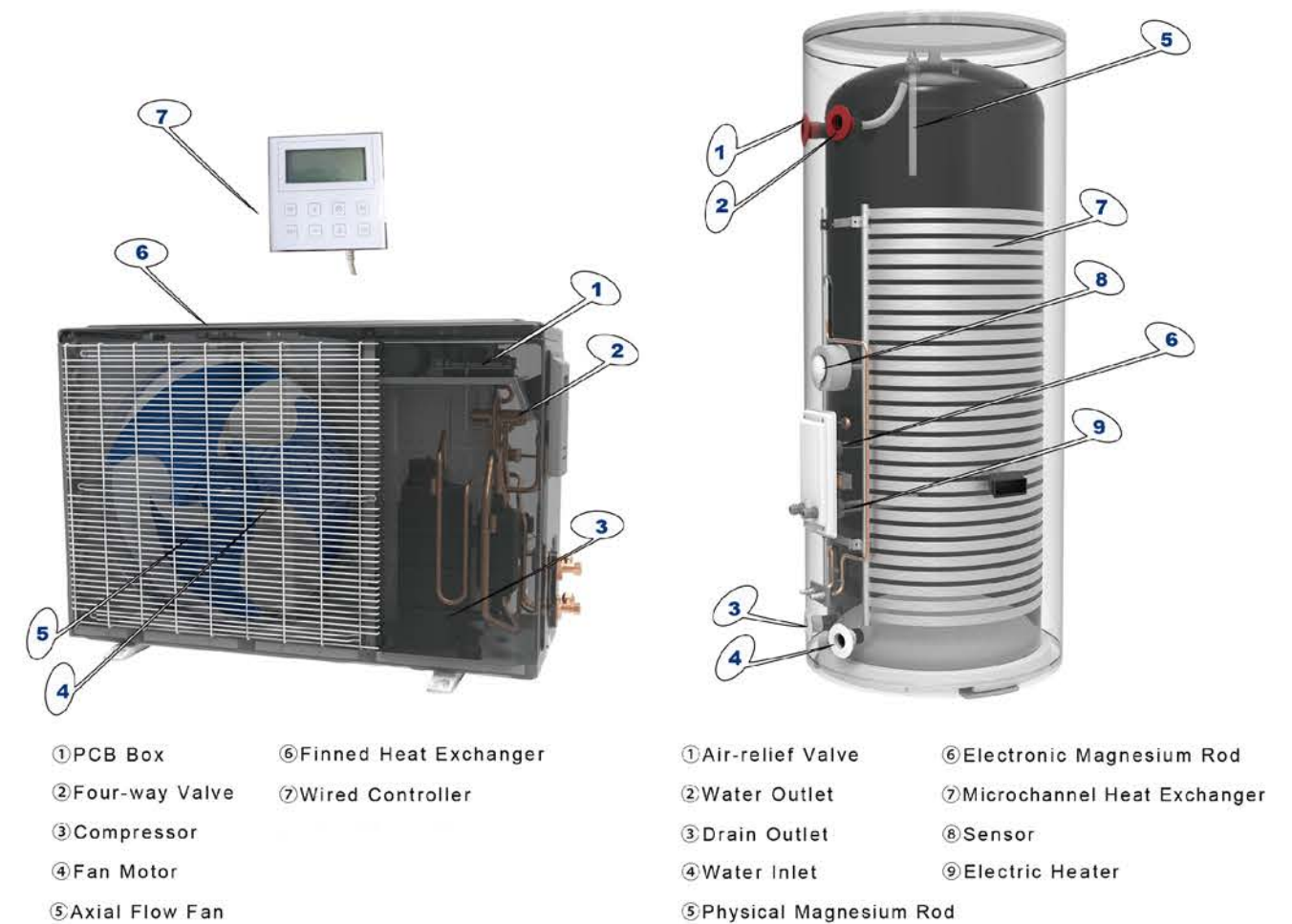

## Features

Supplying Domestic Sanitary Hot Water for bath, shower, washing hand, House Cleaning, Spa, Kitchen.

### Modes: AUTO/ECO

- ◇ Intelligent Fault Testing
- ◇ Intelligent Defrosting
- ◇ Timer
- ◇ Auto-Restart
  
- ◇ Built-in Magnesium Rod & Anion Anode for Anti-corrosion
- ◇ Enamel Water Tank with External Aluminium Micro-channel Coil
- ◇ 50mm Foaming Insulation Material
- ◇ Electronic Expansion Valve for High Efficiency
- ◇ 2kW Auxiliary Electric Heater Back Up for Cold Winter

### Standard Parts:

- Safety Valve
- WATTS PT Valve
- 3M Connection Pipe
- Electric Insulators Connected to Water Inlet and Water Outlet for Electric



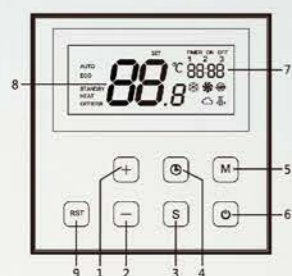

- 1--Plus
- 2--Minus
- 3--Temperature Setting
- 4--Time Setting
- 5-- Mode Setting
- 6--Off/On
- 7--Time Display
- 8--Temperature display, Malfunction code display, Parameter code or Parameter display
- 9--Reset



Model	/	ASbC26R1LW/200E	ASbC26R1LW/300E	ASbC65LW/500E
Outdoor Model	/	ASbC26R1W/E	ASbC26R1W/E	ASbC65W/E
Water Tank Model	/	ASbC26R1L/200E	ASbC26R1L/300E	ASbC65L/500E
Water Tank Volume	L	200	300	500
Applicable Persons	/	4	6	10
Hot Water Yield	L/h	56	56	140
Power Supply	V/Ph/Hz	220~240V/1/50Hz	220~240V/1/50Hz	220~240V/1/50Hz
Mode	/	AUTO/ECO	AUTO/ECO	AUTO/ECO
Water Outlet Temp.(Default/Max.)	°C	55 (Heat Pump)	55 (Heat Pump)	55 (Heat Pump)
Running Ambient Temp.	°C	-20°C~46°C (Heat Pump+E-Heater), -7°C~46°C (Heat Pump)		
Heating Capacity (Heat Pump)	W	2600	2600	6500
Heating Input Power (Heat Pump)	W	650	650	1580
Auxiliary Electric Heater	kW	2	2	2
Rated Input Power (HP+E-Heater)	kW	3.0	3.0	2.7 (HP)
Rated Input Current (HP+E-Heater)	A	13.6	13.6	12 (HP)
Noise	dB(A)	≤52	≤52	≤52
Compressor	/	Highly/Rotary	Highly/Rotary	GMCC/Rotary
Water Side Heat Exchanger	/	Micro-Channel	Micro-Channel	Micro-Channel
Refrigerant	/	R134A	R134A	R410A
Throttling Type	/	EEV	EEV	EEV
Fan Motor	/	AC Motor	AC Motor	AC Motor
Solar Water Coil Surface	/	Optional	Optional	Optional
Boiler Water Coil Surface	/	Optional	Optional	Optional
Water Tank Net /Gross Weight	kg	82 / 86	89 / 92	125 / 140
Water Tank Net Dimension(ΦD×H)	mm	Φ600×1645	Φ650×1570	Φ710×1895
Water Tank Packing Dimension(L×W×H)	mm	725×725×1775	750×720×1700	745×745×2070
Outdoor Net/Gross Weight	kg	32 / 36	32 / 36	42 / 47
Outdoor Net Dimension(L×W×H)	mm	790×285×545	790×285×545	820×300×600
Outdoor Packing Dimension(L×W×H)	mm	925×410×615	925×410×615	950×415×655
Container Loading (20'/40')	Sets	24/48	24/48	20/40

Remark:  
 1、 Test conditions: Ambient Temp.(DB/WB):20°C/15°C, Water Temp.(In/Out):15°C/55°C;  
 2、 The above data may be changed without prior notice for product improvement.

Model	/	ASbC10R1LW/150E
Outdoor Model	/	ASbC10R1W/E
Water Tank Model	/	ASbC10R1L/150E
Water Tank Volume	L	150
Applicable Persons	/	3
Hot Water Yield	L/h	20
Power Supply	V/Ph/Hz	220~240V/1/50Hz
Mode	/	AUTO/ECO/FAST/MULT
Water Outlet Temp. (Default/Max.)	°C	55 (Heat Pump)
Running Ambient Temp.	°C	-20°C~46°C (Heat Pump+E-Heater), -7°C~46°C (Heat Pump)
Heating Capacity (Heat Pump)	W	920
Heating Input Power (Heat Pump)	W	242
Heating Input Current	A	1.1
Auxiliary Electric Heater	kW	2
Rated Input Power (HP+E-Heater)	kW	2.5
Rated Input Current (HP+E-Heater)	A	11.0
Noise	dB(A)	≤55
Compressor	/	Panasonic/Rotary
Water Side Heat Exchanger	/	Micro-Channel
Refrigerant	/	R134A
Throttling Type	/	EEV
Fan Motor	/	AC Motor
Tapping Cycle	/	L
COP <sub>DHW</sub>	W/W	3.84
ErP Class	/	A++
Water Tank Net /Gross Weight	kg	66.5/72
Water Tank Net Dimension (ΦD×H)	mm	Φ600*1400
Water Tank Packing Dimension(L×W×H)	mm	725×725×1525
Outdoor Net/Gross Weight	kg	29 / 33
Outdoor Net Dimension(L×W×H)	mm	790×285×545
Outdoor Packing Dimension(L×W×H)	mm	925×410×615
Container Loading (20'/40')	Sets	27/54

Remark:  
 1、 Test conditions: Base on EN16147:2017. Ambient Temp.(DB/WB):14°C/13°C, Water Temp.(In/Out):20°C/55°C;  
 2、 The above data may be changed without prior notice for product improvement.



# Commercial Hot Water Heat Pump



Intelligent Control



Stable Performance



Famous Brand Compressor



Multiple Protections



Energy Efficient



Modular Control



High-efficiency EEV



High-efficiency Heat Exchanger

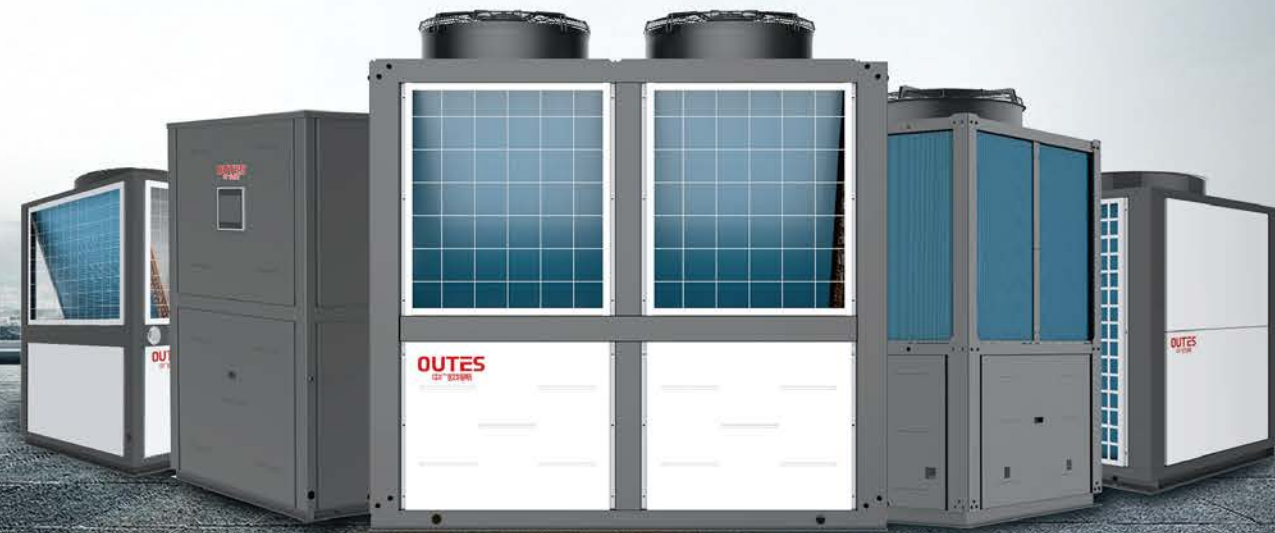

## Features

### Multi-Protection



High and Low Pressure Protection

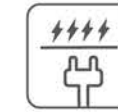

Reverse (Missing) Phase Protection

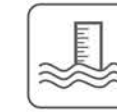

Water Level Protection



Frost Protection



Frequent Activation of Protection



Overcurrent Protection



Discharge Temp. Protection



Leakage Protection

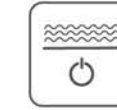

Water Flow Protection



Sensor Failure Protection

### Modular Control

#### ☆ Easy Disassembly and Easy Installation

The Metal coaming can be fully knocked-down for daily maintenance easily.

#### ☆ Start By Stage

The machine is made with modular structure and in the same system, the modules can start by stage with equal distribution of loads to reduce the impact of unit starting current on the power grid and ensure a long life.

#### ☆ Modular Connection

Different models and module can be freely connected and can be parallel running max. 16 units together. And it's easy to compat and extend more different model and module together according to the installation site features.

#### ☆ Modular Backup Running

Modular multi-system design ensure the whole system remain in running even if any error appeared on one or on more compressors or on modular units, because of the different modular unit can be backup for each other.

#### ☆ Modular Rotation Running

The Controller can alternately set the priority for starting which modular unit to balance the working time for all the modular unit, which ensure the reliability and service life of the machine.

#### ☆ Intelligent Control System

Single Wire Controller can control Max. 16 modular connected units, it can control each modular unit of start and stop sequence, control the system running parameter, active warning of faults in the unit and the user can read the running state and failure state from it.

#### ☆ Long Distance Monitoring System

You can control the machine by computer and APP at home at anytime.

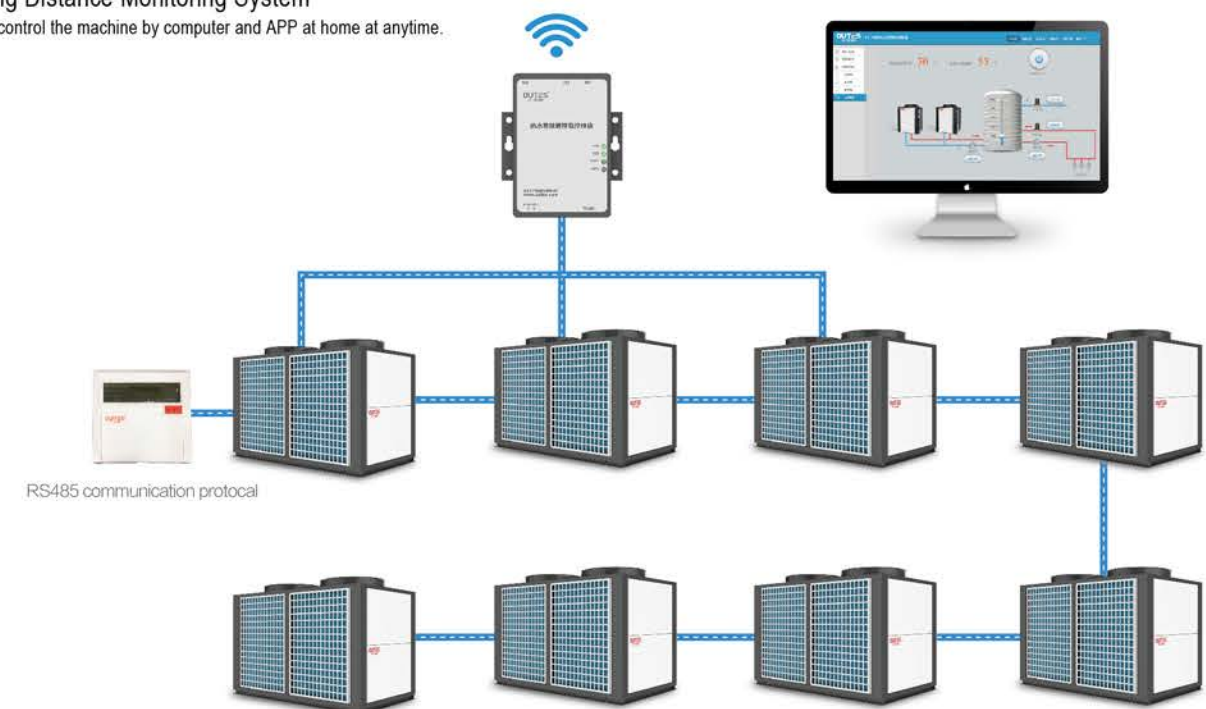

RS485 communication protocol



## Installation Diagram

### Independence-stand-alone system

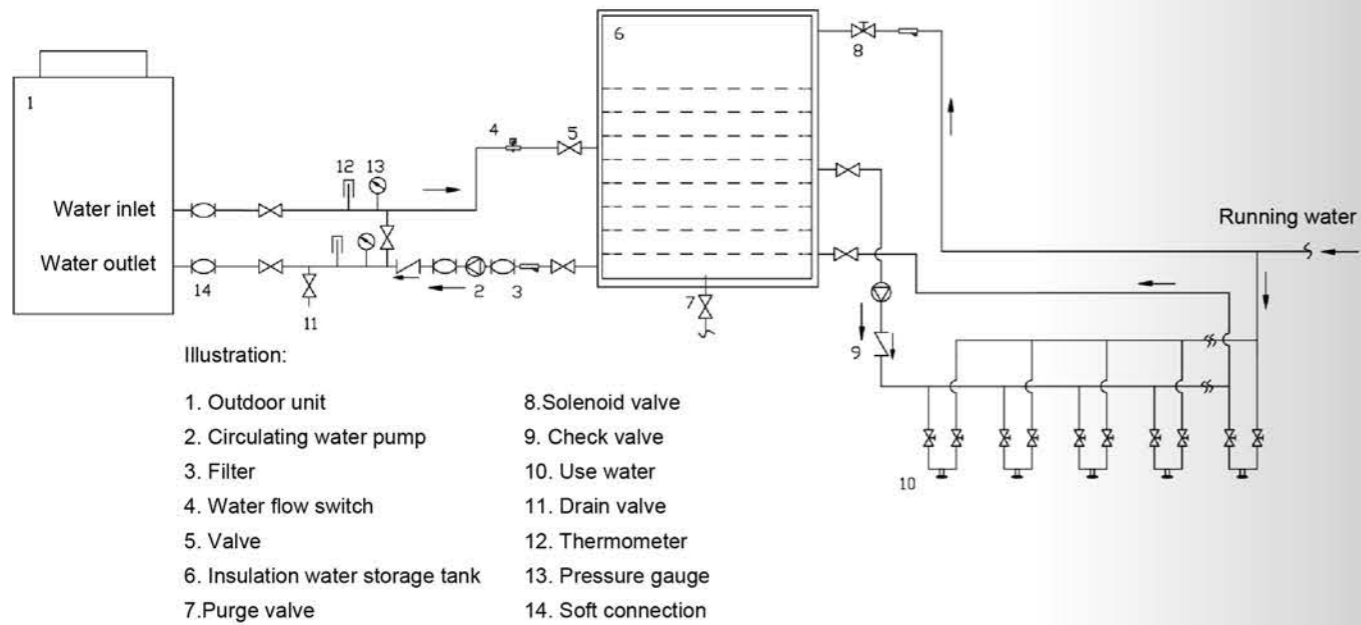

### Modular combination system

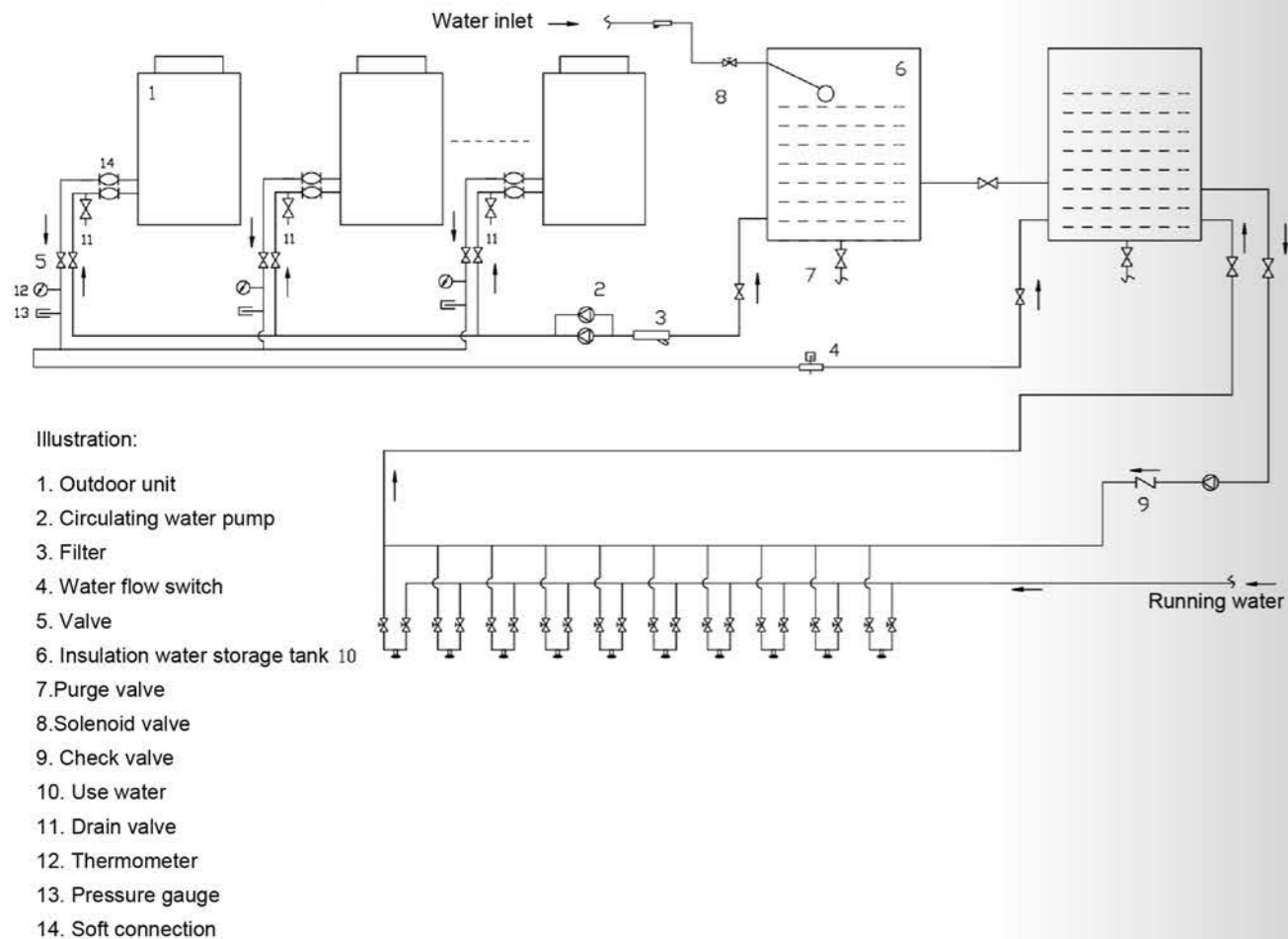

## 80°C Commercial Hot Water Heat Pump



R410a



Model	/	AW16R1e	AW32R1e	AW64R1e	AW85R1e
Power Supply	/	380V/3N/50Hz	380V/3N/50Hz	380V/3N/50Hz	380V/3N/50Hz
Nominal Heating Capacity	kW	16	32	32	84
Rated Input Power	kW	3.6	7.2	7.2	24
COP	W/W	4.44	4.44	4.44	3.5
Water Yield (55°C)	L/h	350	700	700	1810
Max. Input Power	kW	5.7	11.4	11.4	41.1
Max. Working Current	A	11.9	25	25	76
Normal Water Temperature	°C	55	55	55	55
Max. Water Temperature	°C	80	80	80	80
Rated Circulating Water	m³/h	3.9	7.9	7.9	24.0
Noise	dB(A)	≤62	≤64	≤64	≤68
Refrigerant	/	R134A	R134A	R134A	R134A
Compressor Type	/	Scroll	Scroll	Scroll	Scroll
Compressor Qty	Pcs	1	2	2	4
Net Weight	kg	175	350	350	970
Net Dimension(L×W×H)	mm	800×800×1105	1620×950×1180	1620×950×1180	2200×1250×2250
Packing Dimension(L×W×H)	mm	880×840×1185	1700×990×1260	1700×990×1260	2260×1260×2265

Remark:

- Test conditions: Ambient Temp.(DB/WB):20°C/15°C, Water Temp.(In/Out):15°C/80°C;
- The data above is only for reference, and might be changed without prior notice.



# 60°C Commercial Hot Water Heat Pump



R410a



Model	/	AW19e	AW36e	AW45e	AW90e	AW110e	AW190e	AW220e
Power Supply	/	380V/3N/50Hz	380V/3N/50Hz	380V/3N/50Hz	380V/3N/50Hz	380V/3N/50Hz	380V/3N/50Hz	380V/3N/50Hz
Heating Capacity	kW	19	36	46.5	93	110	190	220
Heating Input Power	kW	4.28	8.14	10.81	20.00	24.18	40.25	47.31
COP	WW	4.44	4.42	4.3	4.65	4.55	4.72	4.65
Max Input Power	kW	7.49	14.25	15.61	35.00	42.31	70.44	82.80
Max Working Current	A	14.22	27.07	31.20	66.47	80.35	133.79	157.25
Suggested Water Temp.	°C	55	55	55	55	55	55	55
Max Water Temp.	°C	60	60	60	60	60	60	60
Water Yield	L/h	409	775	1000	2002	2368	4091	4737
Rated Circulating Water	m³/h	3.27	6.19	8.0	16.0	18.92	32.68	37.84
Noise	dB(A)	≤62	≤64	≤64	≤68	≤68	≤70	≤71
Refrigerant	/	R410A	R410A	R410A	R410A	R410A	R410A	R410A
Compressor Type	/	Copland/Scroll	Copland/Scroll	Copland/Scroll	Danfoss/Scroll	Copland/Scroll	Danfoss/Scroll	Danfoss/Scroll
Compressor Qty	Pcs	1	2	1	2	2	4	6
Water side Heat Exchange	/	Tube in tube	Tube in tube	Tube in tube	Tube in tube	Tube in tube	Tube in tube	Tube in tube
Water Pump Built in	/	None	None	None	None	None	None	None
Net Weight	kg	175	350	400	660	750	1540	2180
Net Dimension(L×W×H)	mm	800×800×1105	1620×950×1180	1800×1000×1150	2042×1170×2128	2042×1170×2128	2150×1850×2200	2150×1850×2200
Packing Dimension(L×W×H)	mm	998×888×1246	1740×1000×1300	1880×1050×1270	2120×1220×2300	2120×1220×2300	2300×1930×2360	2300×1930×2360

Remark:  
 1. Test conditions: Ambient Temp. (DB/WB): 20°C/15°C, Water Temp. (In/Out): 15°C/55°C;  
 2. The data above is only for reference, and might be changed without prior notice.

# 60°C Commercial Hot Water Heat Pump (EVI)

EVI Compressor Workable at -25°C



R410a



Model	/	AW34Ee	AW42Ee	AW70Ee	AW85Ee	AW100Ee	AW160Ee	AW220e
Power Supply	/	380V/3N/50Hz	380V/3N/50Hz	380V/3N/50Hz	380V/3N/50Hz	380V/3N/50Hz	380V/3N/50Hz	380V/3N/50Hz
Nominal Heating Capacity	kW	31.6	38	68	78	92	156	180
Rated Input Power	kW	8.08	9.1	16.8	19	21.6	38.0	42.0
COP	WW	3.91	4.18	4.05	4.11	4.26	4.11	4.29
Rated Working Current	A	15.3	17.3	31.91	36.1	41.0	72.2	79.8
Max Input Power	kW	11	13.5	29.23	27	29.7	52.3	57.8
Max Working Current	A	26.5	37	68	74	82.7	136.0	150.0
Max Water Temperature	°C	55	55	55	55	55	55	55
Water Yield	L/h	592	711	1273	1460	1722	2921	3370
Rated Circulating Water	m³/h	5.4	6.5	11.7	13.4	15.8	26.8	31.0
Water Pressure Loss	kPa	60	55	60	70	70	70	70
Circulating Pipe Diameter	/	DN40	DN40	DN50	DN65	DN65	DN65	DN80
Max Air Exhaust/Absorb Working Pressure	MPa	4.2/1.5	4.2/1.5	4.2/1.5	4.2/1.5	4.2/1.5	4.2/1.5	4.2/1.5
Noise	dB(A)	≤64	≤68	≤68	≤70	≤70	≤72	≤73
Refrigerant	/	R410A	R410A	R410A	R410A	R410A	R410A	R410A
Compressor Type	/	Scroll	Scroll	Scroll	Scroll	Scroll	Scroll	Scroll
Compressor Qty	Pcs	2	2	2	2	2	4	4
Net Weight	kg	350	400	690	710	810	1250	1540
Net Dimension(L×W×H)	mm	1730×950×1640	1110×900×1800	2042×1170×2128	2042×1170×2128	2042×1170×2128	2200×1450×2220	2042×1850×2220
Packing Dimension(L×W×H)	mm	1810×1010×1720	1190×960×1900	2120×1220×2300	2120×1220×2300	2120×1220×2300	2270×1470×2400	2112×1870×2400

Remark:  
 1. Test conditions: Ambient Temp. (DB/WB): 7°C/6°C, Water Temp. (In/Out): 9°C/55°C;  
 2. The data above is only for reference, and might be changed without prior notice.



# Commercial Heating & Cooling Heat Pump



- Cooling&Heating
- Friendly Refrigerant
- Wide-range Operation
- Modular Control
- Small Footprint
- High Efficiency&Energy Saving
- Stable Performance
- Multi-level Capacity Adjustment
- Intelligent Control System

## Features

### Multi-Protection

- High and Low Pressure Protection
- Reverse (Missing) Phase Protection
- Frost Protection
- Prevent Freezing
- Frequent Restart Protection
- Overload Protection
- Discharge Temp. Protection
- Overheat Protection
- Water Flow Protection
- Sensor Failure Protection

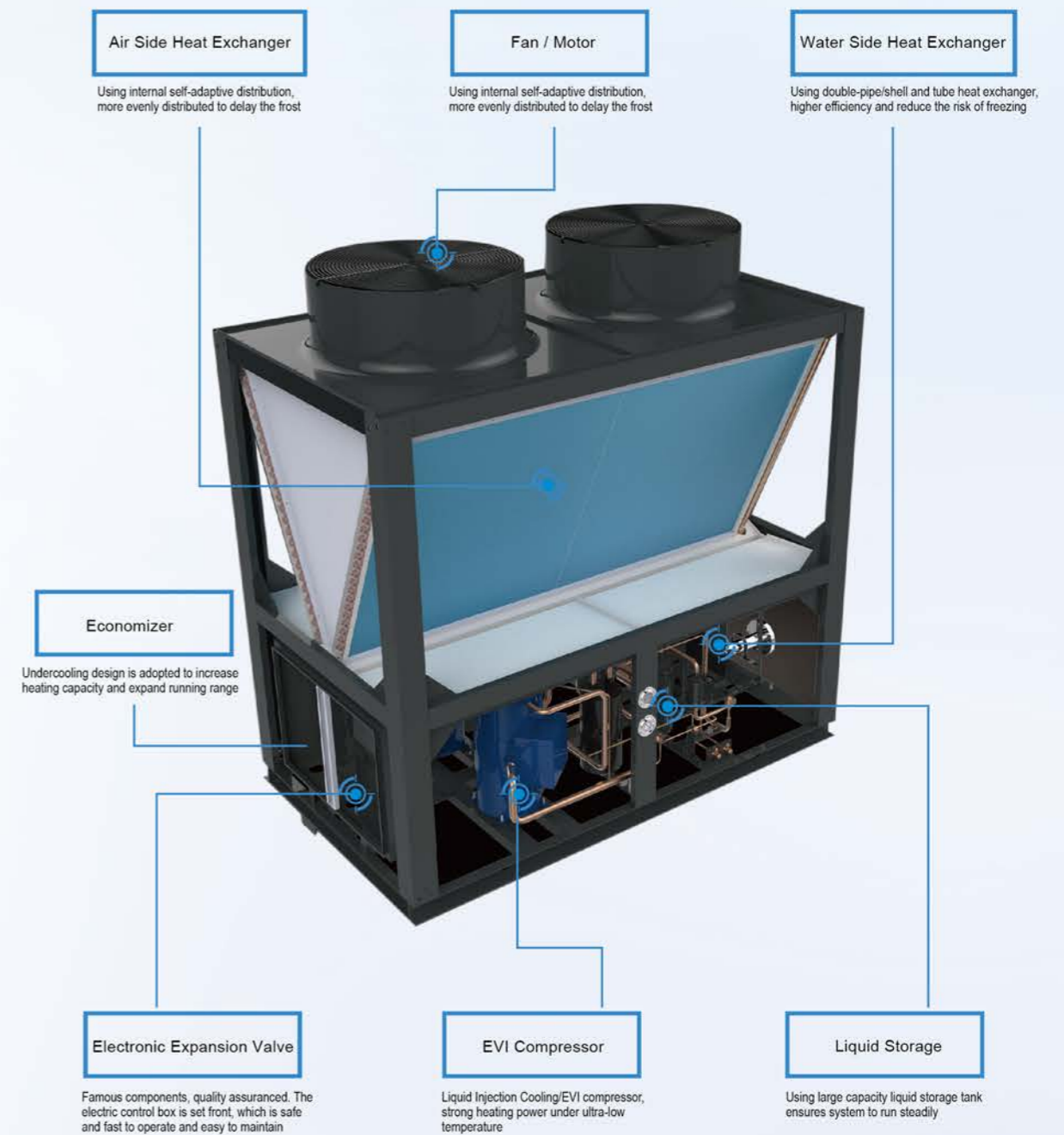



## Modular Control

### ☆ Easy Disassembly and Easy Installation

The Metal coaming can be fully knocked-down for daily maintenance easily.

### ☆ Start By Stage

The machine is made with modular structure and in the same system, the modules can start by stage with equal distribution of loads to reduce the impact of unit starting current on the power grid and ensure a long life.

### ☆ Modular Connection

Different models and module can be freely connected and can be parallel running max. 16 units together. And it's easy to compat and extend more different model and module together according to the installation site features.

### ☆ Modular Backup Running

Modular multi-system design ensure the whole system remain in running even if any error appeared on one or on more compressors or on modular units, because of the different modular unit can be backup for each other.

### ☆ Modular Rotation Running

The Controller can alternately set the priority for starting which modular unit to balance the working time for all the modular unit, which ensure the reliability and service life of the machine.

### ☆ Intelligent Control System

Single Wire Controller can control Max. 16 modular connected units, it can control each modular unit of start and stop sequence, control the system running parameter, active warning of faults in the unit and the user can read the running state and failure state from it.

### ☆ Long Distance Monitoring System

You can control the machine by computer and APP at home at anytime.

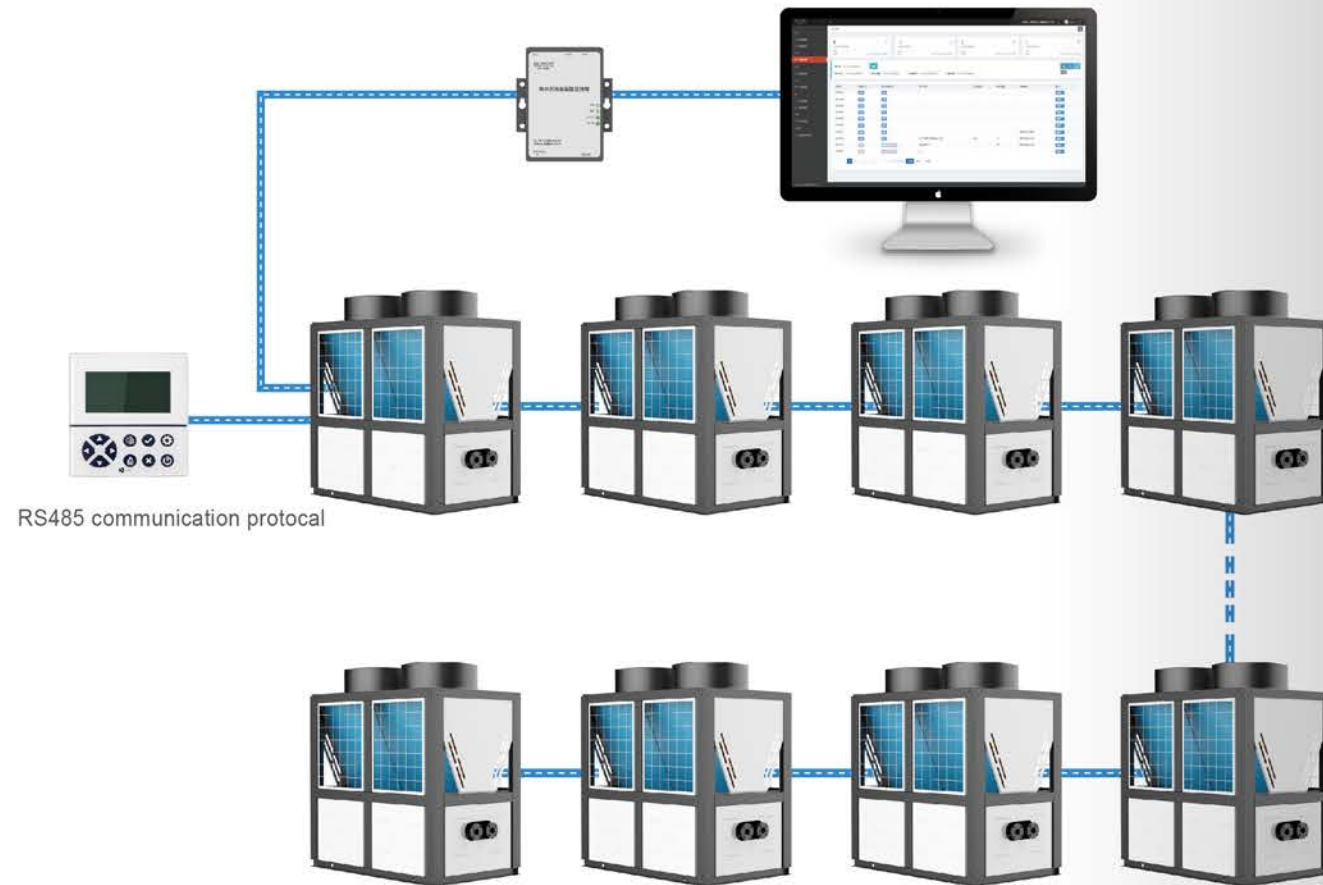

## Primary Circulation System

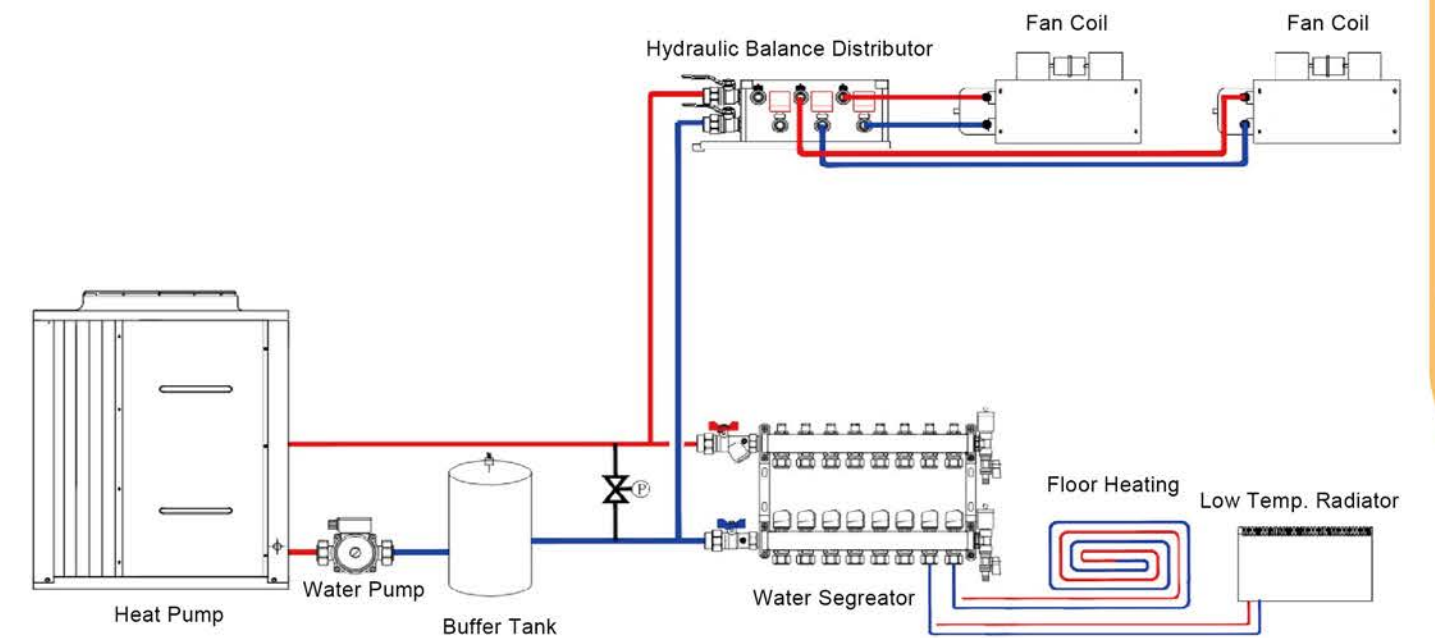

## Secondary Circulation System

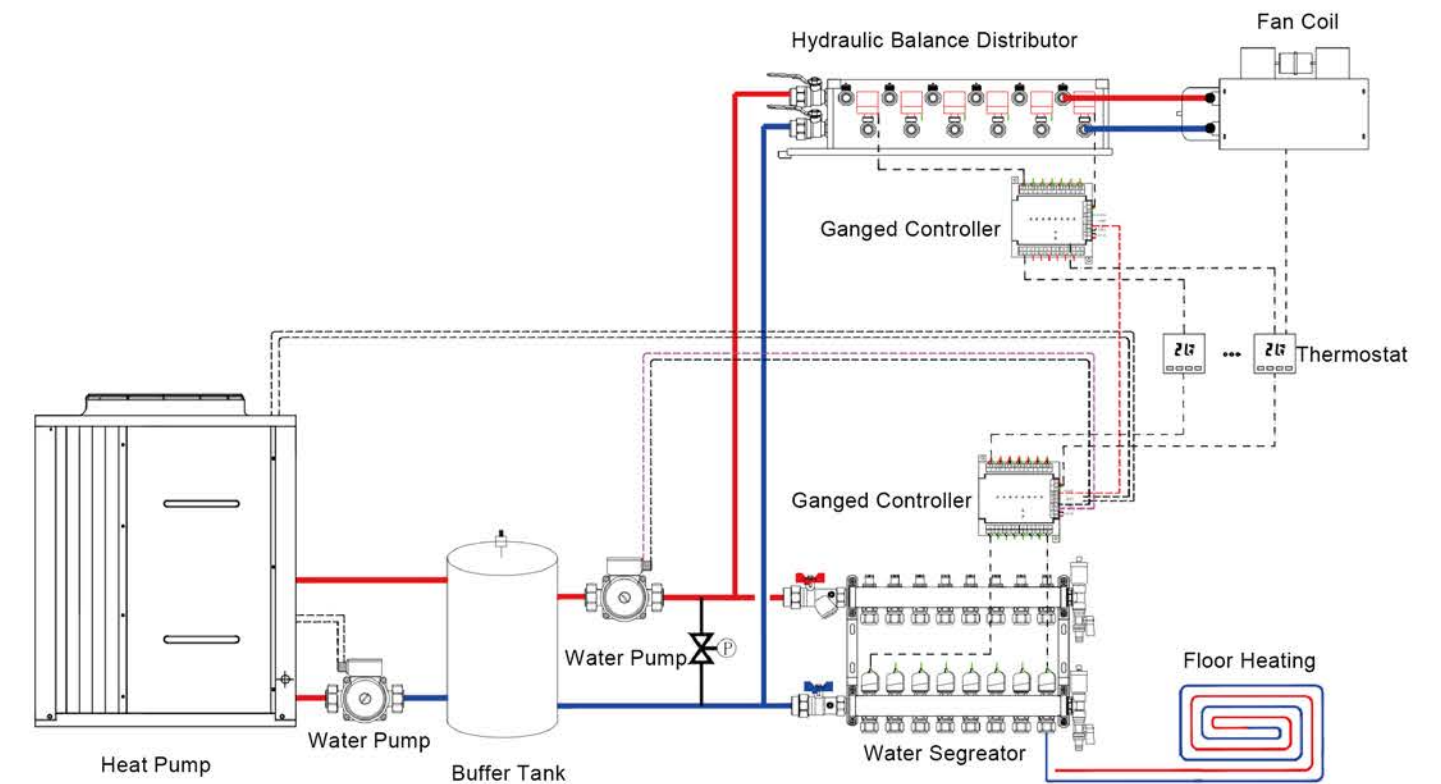



# Commercial Heating & Cooling System Installation Schematic

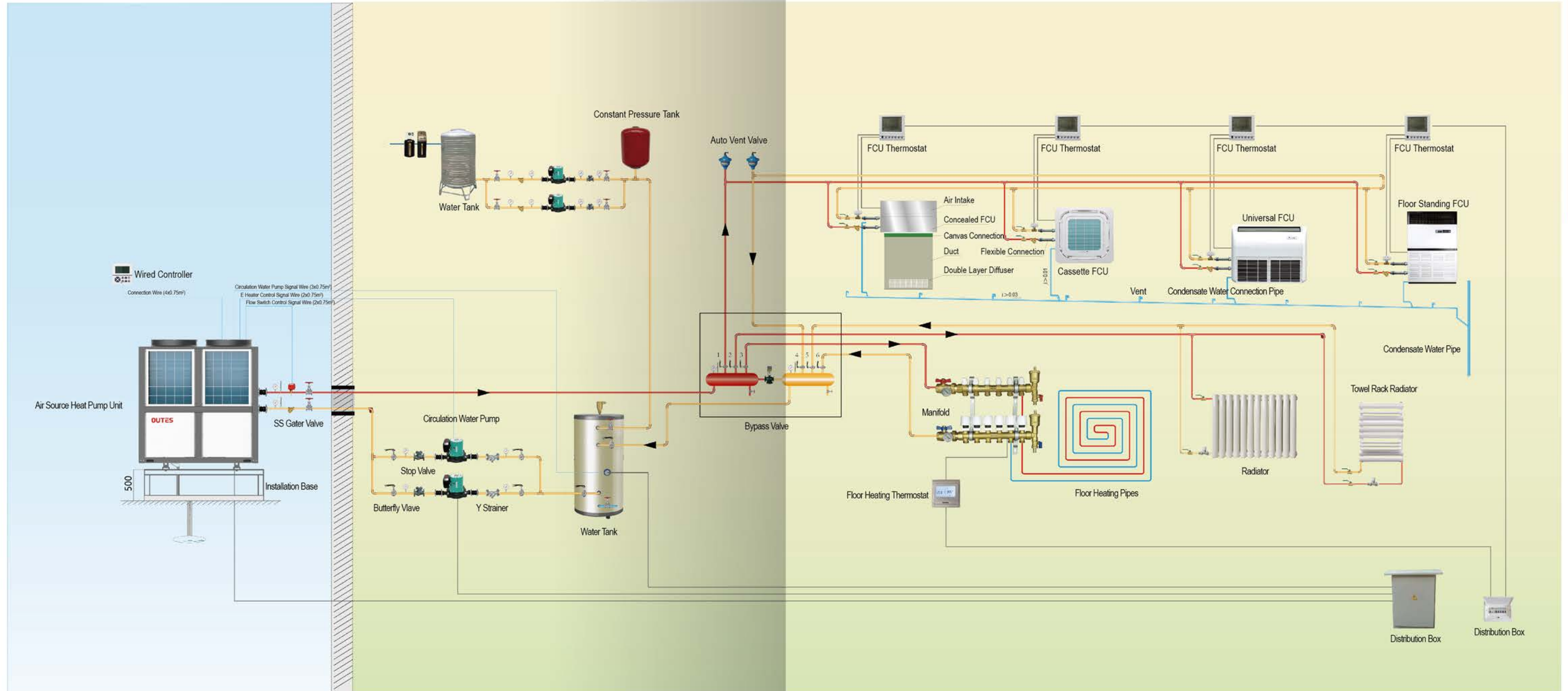

## Projects



Helingeer Town, the Nei Monggol Autonomous Region  
 Heating Area: 100,000m<sup>2</sup>  
 Heat Pump: 150kW/unit Total: 80Units



Baizhai Town, Xinmi City, Henan Province  
 Heating Area: 600,000m<sup>2</sup>  
 Heat Pump: 150kW/unit Total: 130Units



Liaoning Province Dalin City Vocational Technical School  
 Heating Area: 150,000m<sup>2</sup>  
 Heat Pump: mixed models Total: 130Units



Cuipinglijing Community, Pingyin Meigui Town, Ji Nan City  
 Heating Area: 300,000m<sup>2</sup>  
 Heat Pump: 150kW/unit Total: 90Units



# Commercial Heating & Cooling Heat Pump (EVI)

## Hydraulic Kits(Optional)

Hydro Box	Model	/	AHa09E/HP	AHb15E/HP	AHa19E/HP	Optional
	Power Supply	/	220V-240V/50Hz	220V-240V/50Hz	220V-240V/50Hz	
	Electric Heater	KW	3.0	3.0	3.0	Electric Heater
	Water Pump Brand	/	Grundfos	Grundfos	Grundfos	Water Pump
	Water Flow	m³/h	1.46	2.5	3.18	
	Pump Input Power	W	140	180	180	
	Expansion Tank Volume	L	5.0	5.0	5.0	Expansion Tank
	Noise	dB(A)	≤30	≤30	≤30	
	Net Weight	kg	35	35	35	
	Net Dimension (L×W×H)	mm	520×800×308	520×800×308	520×800×308	
	Packing Dimension (L×W×H)	mm	570×870×420	570×870×420	570×870×420	
Hydraulic Box Including 3kW Electric Heater, Water Pump, Three Way Valves, Expansion Tank 5L, Discharge Valve						

R410a



9kW 15-19kW

Model	/	AHa09E	AHa15E	AHa19E	
Power Supply	/	220~240V/1N/50Hz	220~240V/1N/50Hz	220~240V/1N/50Hz	
Heating- A7 C/W35 C	Rated Heating Capacity(1)	KW	8.5	14.5	18.5
	Heating Input Power(1)	KW	2.15	16.0	4.64
	COP(1)	WW	3.95	3.93	3.99
Heating- A7 C/W45 C	Rated Heating Capacity(2)	KW	8.2	13.9	17.8
	Heating Input Power(2)	KW	2.66	4.19	5.31
	COP(2)	WW	3.08	3.32	3.35
Cooling (A35 C/W7 C)	Rated Cooling Capacity	KW	6.7	10	13.4
	Cooling Input Power	KW	2.6	4.1	5.2
	EER	WW	2.58	2.44	2.58
Outdoor Unit	Rated Input Power	KW	3.4	5.9	6.9
	Working Condition	°C	-25~49	-25~49	-25~49
	Refrigerant Type	/	R410A	R410A	R410A
	Compressor Brand	/	Copland/scroll	Copland/scroll	Copland/scroll
	Compressor Type	/	ON/OFF	ON/OFF	ON/OFF
	Water Side Heat Exchanger	/	Plate	Plate	Plate
	Rated Water Flow	m³/h	1.46	2.49	3.18
	Noise Level	dB(A)	≤60	≤62	≤63
	Net Weight	kg	100	150	160
	Net Dimension (L×W×H)	mm	1036×406×740	1036×406×1410	1036×406×1410
	Packing Dimension (L×W×H)	mm	1086×446×820	1086×446×1490	1086×446×1490
	Container Loading(20'/40'/40'H)	Unit	54/108/162	27/54/54	27/54/54

Remark:  
 1. Condition Heating: Ambient Temp.(DB/WB):7 C/6 C , Water Temp.(In/Out):30 C/35 C.  
 2. Condition Heating: Ambient Temp.(DB/WB):7 C/6 C , Water Temp.(In/Out):40 C/45 C.  
 3. Cooling : Ambient Temp.(DB/WB):35 C/24 C , Water Temp.(In/Out):12 C/7 C.  
 4. The above data test reference EN14825:2016.  
 5. The above data is for reference only and might be changed without prior notice.

R410a



Model	/	AHa40Ee	AHa45Ee	AHa90Ee	AHa180Ee	
Power Supply	/	380V/3N/50Hz	380V/3N/50Hz	380V/3N/50Hz	380V/3N/50Hz	
Heating- A7 C/W35 C	Rated Heating Capacity(1)	KW	39.4	45.2	90.3	176.4
	Heating Input Power(1)	KW	10.2	11.6	21.4	51.2
	COP(1)	WW	3.85	3.90	4.21	3.45
Heating- A7 C/W45 C	Rated Heating Capacity(2)	KW	37.5	43.0	86.0	168.0
	Heating Input Power(2)	KW	11.3	12.3	23.5	48.8
	COP(2)	WW	3.3	3.5	3.7	3.44
Cooling (A35 C/W7 C)	Rated Cooling Capacity	KW	34.5	37.5	69.0	135.0
	Cooling Input Power	KW	11.5	13.2	23.7	40.3
	EER	WW	3.00	2.84	2.91	3.35
Outdoor Unit	Rated Input Power	KW	19.7	22.0	38.2	72.4
	Working Condition	°C	-25~49	-25~49	-25~49	-25~49
	Refrigerant Type	/	R410A	R410A	R410A	R410A
	Compressor Brand	/	Danfoss/Scroll	Copeland/scroll	Copland/scroll	Danfoss/Scroll
	Compressor Type	/	ON/OFF	ON/OFF	ON/OFF	ON/OFF
	Water Side Heat Exchanger	/	Shell-and-tube	Shell-and-tube	Shell-and-tube	Shell-and-tube
	Rated Water Flow	m³/h	5.9	6.5	11.9	30.3
	Noise Level	dB(A)	≤65	≤65	≤68	≤70
	Net Weight	kg	380	380	910	1480
	Net Dimension (L×W×H)	mm	1600×900×1660	1600×900×1660	2042×1170×2128	2200×1450×2350
	Packing Dimension (L×W×H)	mm	1650×1010×1760	1650×1010×1760	2220×1286×2340	2320×1510×2480
	Container Loading(20'/40'/40'H)	Unit	12/24/24	12/24/24	5/9/9	4/8/8

Remark:  
 1. Condition Heating: Ambient Temp.(DB/WB):7 C/6 C , Water Temp.(In/Out):30 C/35 C.  
 2. Condition Heating: Ambient Temp.(DB/WB):7 C/6 C , Water Temp.(In/Out):40 C/45 C.  
 3. Cooling : Ambient Temp.(DB/WB):35 C/24 C , Water Temp.(In/Out):12 C/7 C.  
 4. The above data test reference EN14825:2016.  
 5. The above data is for reference only and might be changed without prior notice.



## Commercial Heating Only Heat Pump (EVI)

R410a



45-50kW

180kW

Model	/	AHh45Ee	AHh50Ee	AHh180Ee	
Power Supply	/	380V/3N/50Hz	380V/3N/50Hz	380V/3N/50Hz	
Heating- A7°C/W35°C	Heating Capacity	kW	42.0	47.3	178.5
	Heating Input Power	kW	10.9	12.1	47.0
	COP	W/W	3.85	3.90	3.80
Heating- A7°C/W45°C	Rating Heating Capacity	kW	40.0	45.0	170.0
	Heating Input Power	kW	11.3	12.7	47.90
	COP	W/W	3.54	3.54	3.55
Heating- A-12W41	Rating Heating Capacity	kW	19.9	23.5	92.1
	Heating Input Power	kW	9.02	10.6	40.3
	COP	W/W	2.21	2.22	2.27
Outdoor Unit	Rated Input Power	kW	16.6	17.6	70.6
	Min. Working Temperature (Heating)	°C	-30	-30	-30
	Refrigerant Type	/	R410A	R410A	R410A
	Compressor Brand/Type	/	Danfoss/Scroll	Danfoss/Scroll	Danfoss/Scroll
	Capacity Adjustable	/	ON/OFF	ON/OFF	ON/OFF
	Water side Heat Exchanger	/	Tube in Tube	Tube in Tube	Tube in Tube
	Rated Water Flow	m³/h	6.9	7.7	29.2
	Noise	dB(A)	≤65	≤65	≤70
	Net Weight	kg	400	450	1480
	Net Dimension (L×W×H)	mm	1600×900×1660	1600×900×1660	2860×1450×2335
	Packing Dimension (L×W×H)	mm	1650×1010×1760	1650×1010×1760	2930×1500×2450
	Container Loading(20'/40'/40'H)	Unit	7/14/14	7/14/14	4/8/8

Remark:  
 1. Heating: Ambient temp. (DB/WB): 7°C/6°C, Water temp. (In/Out): 30°C/35°C;  
 2. Cooling: Ambient temp. (DB/WB): 35°C/24°C, Water temp. (In/Out): 12°C/7°C;  
 3. The above data is for reference only and might be changed without prior notice.

## Commercial Heating & Cooling Heat Pump

R410a



65kW

130kW

Model	/	AHc65e	AHc130e	
Power Supply	/	380V/3N/50Hz	380V/3N/50Hz	
Cooling- A35°C/W7°C	Rating Cooling Capacity	kW	65.0	130.0
	Cooling Input Power	kW	20.3	40.6
	EER	W/W	3.20	3.20
Heating- A7°C/W35°C	Heating Capacity	kW	73.5	147.0
	Heating Input Power	kW	19.1	37.7
	COP	W/W	3.85	3.90
Heating- A7°C/W45°C	Rating Heating Capacity	kW	70.0	140.0
	Heating Input Power	kW	20.5	41.0
	COP	W/W	3.41	3.41
Outdoor Unit	Rated Input Power	kW	30.5	60.6
	Min. Working Temperature (Heating)	°C	-15	-15
	Refrigerant Type	/	R410A	R410A
	Compressor Brand/Type	/	Copeland/Scroll	Copeland/Scroll
	Capacity Adjustable	/	ON/OFF	ON/OFF
	Water side Heat Exchanger	/	Shell&Tube	Shell&Tube
	Rated Water Flow	m³/h	11.2	22.4
	Noise	dB(A)	≤65	≤68
	Net Weight	kg	590	1000
	Net Dimension (L×W×H)	mm	1930×941×2135	2340×1500×2350
	Packing Dimension (L×W×H)	mm	1980×1040×2235	2390×1550×2450
	Container Loading(20'/40'/40'H)	Unit	6/12/12	N/A/5/5

Remark:  
 1. Cooling: Ambient temp. (DB/WB): 35°C/24°C, Water temp. (In/Out): 12°C/7°C  
 2. Heating: Ambient temp. (DB/WB): 7°C/6°C, Water temp. (In/Out): 30°C/35°C  
 3. The above data is for reference only and might be changed without prior notice.



# Residential Swimming Pool Heat Pump



## Specification

### Features



#### TITANIUM HEAT EXCHANGER

Such coils could extended heat exchanging surface with higher efficiency and avoid scaling.

#### DC INVERTER COMPRESSOR

Selected world famous DC inverter compressor is well compatible with components inside the unit, which ensures the unit operates in an efficient way.



Model	/	APaC7VR3G1	APaC10VR3G1	APaC16VR3G1	APaC18VR3G1	APaC21VR3G1	APaC25VR3G1	
Power Supply	V/Ph/Hz	220-240V/1N/50Hz	220-240V/1N/50Hz	220-240V/1N/50Hz	220-240V/1N/50Hz	220-240V/1N/50Hz	220-240V/1N/50Hz	
Setting Temp. Range	°C	15°C~35°C	15°C~35°C	15°C~35°C	15°C~35°C	15°C~35°C	15°C~35°C	
Running Temp. Range	°C	12°C~43°C	12°C~43°C	12°C~43°C	12°C~43°C	12°C~43°C	12°C~43°C	
Heating power Air 26°C /Water 26°C[1]	Heating Capacity	KW	7.64	9.02	16.3	18.4	21.2	25.2
		Btu	26068	30776	55616	62781	72334	85982
	Heating Input Power	KW	0.13~1.23	0.20~1.53	0.32~2.77	0.35~3.07	0.41~3.41	0.48~4.25
	COP	WW	16.16~6.23	14.5~5.90	14.50~5.89	14.98~5.99	14.7~6.22	14.62~5.93
Heating power Air 15°C /Water 26°C[2]	Heating Capacity	KW	5.48	6.69	12	14.3	16.5	18.4
	Heating Input Power	KW	0.14~1.17	0.22~1.49	0.37~2.69	0.44~3.2	0.49~3.64	0.58~4.22
	COP	WW	7.62~4.67	6.93~4.49	8.26~4.46	8.26~4.47	8.25~4.53	8.27~4.36
Compressor Brand	/	GMCC	GMCC	GMCC	GMCC	GMCC	GMCC	
Max. Current	A	7.2	9	16	17.5	19	21.5	
Refrigerant Type	/	R32	R32	R32	R32	R32	R32	
Condenser	Type	Titanium in PVC	Titanium in PVC	Titanium in PVC	Titanium in PVC	Titanium in PVC	Titanium in PVC	
Controller Display	/	LCD	LCD	LCD	LCD	LCD	LCD	
Hydraulic Connection	mm	50/50	50/50	50/50	50/50	50/50	50/50	
Minimum Water Flow	m³/h	2~3	3~4	5~7	6~8	7~9	8~10	
Sound Pressure level (at 1m)	dB(A)	36~46	38~49	41~50	42~51	43~53	44~55	
Net Weight	kg	33	36	56	61	76	84	
Gross Weight	kg	39	42	66	71	85	93	
Net Dimensions (LxWxH)	mm	844*385*590	844*385*590	935*385*656	935*385*656	1118*465*776	1118*465*776	
Packing Dimensions(LxWxH)	mm	912*417*638	912*417*638	995*435*710	995*435*710	1172*513*833	1172*513*833	
Loading Quantity (20/40H)	Unit	120/276	120/276	87/180	87/180	36/126	36/126	

Remark:  
 1、 Test conditions:  
 [1] Ambient air temperature 26 °C (DB)/19 °C (WB), inlet water temperature 26 °C  
 [2] Ambient air temperature 15 °C (DB)/12 °C (WB), inlet water temperature 26 °C  
 2、 The data above is only for reference, and might be changed without prior notice.



# Commercial Swimming Pool Heat Pump



## Specification



Model	/	APb18e	APb30e	APb36e	APb45e	APb60e	APb90e	APb110e	APb180e	APb220e
Power Supply	/	380V/3N/50Hz	380V/3N/50Hz	380V/3N/50Hz	380V/3N/50Hz	380V/3N/50Hz	380V/3N/50Hz	380V/3N/50Hz	380V/3N/50Hz	380V/3N/50Hz
Heating Capacity	kW	20	30	40	46.5	60	92	110	186	222.5
	Btu/h	68240	102360	136480	158658	204720	313904	375320	634632	759170
Heating Power Input	kW	3.99	5.9	7.8	9.1	10.7	18.1	21.6	36.1	42.6
COP	W/W	5.01	5.08	5.10	5.10	5.60	5.08	5.10	5.15	5.22
MAX. Working Power	kW	6.5	9.60	12.8	14.8	18.8	29.5	35.2	58.90	69.5
MAX. Working Current	A	13.2	17	25.9	30	40	44	69	115	120
Noise	dB(A)	≤60	≤60	≤63	≤64	≤70	≤74	≤74	≤74	≤74
Rated Water Temperature	°C	28	28	28	28	28	28	28	28	28
Max. Water Temperature	°C	40	40	40	40	40	40	40	40	40
Rated Circulating Water	m³/h	8.6	12.9	17.2	20.0	25.8	39.6	47.3	80.0	95.7
Refrigerant	/	R410A	R410A	R410A	R410A	R410A	R410A	R410A	R410A	R410A
Compressor Type	/	Scroll	Scroll	Scroll	Scroll	Scroll	Scroll	Scroll	Scroll	Scroll
Compressor Quantity	Pcs	1	1	2	1	2	2	2	4	4
Water Side Heat Exchanger	Type	Titanium	Titanium	Titanium	Titanium	Titanium	Titanium	Titanium	Titanium	Titanium
Suitable Swimming Pool Size	m³	50~70	70~100	80~140	120~180	160~230	180~270	190~300	300~500	400~600
Net Weight	kg	126	290	270	380	530	690	910	1450	1540
Net Dimensions(L×W×H)	mm	760×760×945	1700×788×1010	1540×900×1050	1600×900×1660	2130×1000×1735	2042×1170×2128	2040×1170×2128	2150×1850×2220	2150×1850×2220
Packing Dimensions(L×W×H)	mm	860×860×1045	1770×870×1180	1640×1000×1150	1700×1000×1760	2230×1100×1835	2250×1270×2230	2250×1270×2230	2250×1950×2320	2250×1950×2320

### Remark:

- Test conditions: Heating: Outdoor air temp(DB/WB): 24°C/19°C, Water temp(in):26°C;  
 \*Heating: Outdoor air temp(DB/WB): 15°C/12°C, Water temp(in):26°C;  
 \*\*Heating: Outdoor air temp(DB/WB): 7°C/6°C, Water temp(in):26°C;
- The data above is only for reference, designs and specifications might be changed without prior notice.



# Floor Standing Type Fan Coil



## Features

- ☆ Easy Disassembly and Easy Installation  
The shell is made of color steel plate with coating on the outside, which is easy to install or remove.
- ☆ ABS Grille  
The inlet style grille is formed by ABS, with forward wind and bottom wind (optional).
- ☆ Filter  
Disassemble and wash the filter for synthesis class, easy to clean.
- ☆ Heat Exchanger  
Composed of copper pipe and hydrophilic aluminum foil, with exhaust valve, the left and right structures are interchangeable.
- ☆ Condensate Drain Pan  
Horizontal and vertical drain pan (universal available).
- ☆ Fan Motor  
Centrifugal fan, 3-speed motor.
- ☆ Electric Heating  
PTC electric heater (optional).
- ☆ Control Valve  
Two-way valve or three-way valve (optional)
- ☆ Control System  
Three-speed switch, thermostat, remote control (optional)
- ☆ Surface-mounted fan coil unit can be vertical/wall-mounted/suspended
- ☆ Air volume range: 340-2040m<sup>3</sup>/h (220-1200CFM)
- ☆ Rang of cooling capacity: 2.0-10.8kW

## Dimensions

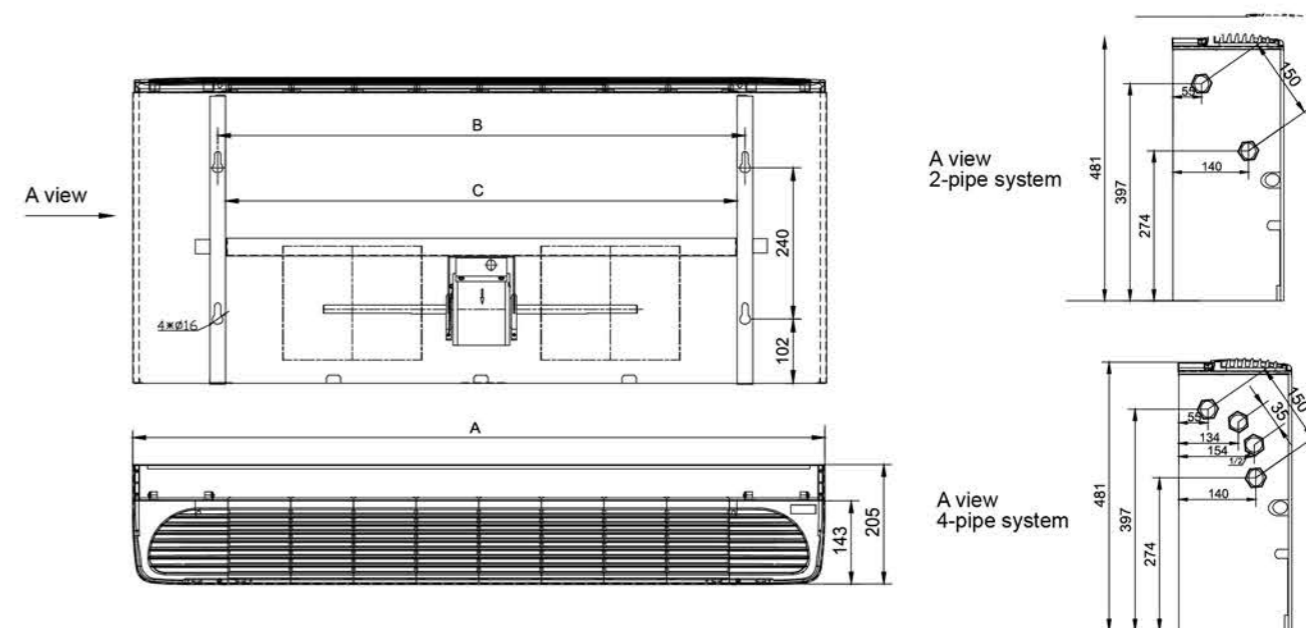

Model	FP-34UM	FP-51UM	FP-68UM / FP-85UM	FP-102UM / FP-136UM	FP-170UM / FP-204UM
A	805	905	1105	1605	1905
B	525	625	825	1325	1625
C	500	600	800	1300	1600

The height of the support feet is 100mm(optional)

Unit: mm



# Specification



Model	/		FP-34UM	FP-51UM	FP-68UM	FP-85UM	
CFM	/		200	300	400	500	
Power Supply	/		220-240V/1N/50Hz	220-240V/1N/50Hz	220-240V/1N/50Hz	220-240V/1N/50Hz	
Air Flow Rate	H	m³/h	380	510	680	850	
	M	m³/h	300	420	550	680	
	L	m³/h	250	360	450	550	
Cooling	Total Capacity	H	kW	2.0	2.7	3.8	4.5
		M	kW	1.6	2.3	3.0	3.8
		L	kW	1.3	1.9	2.5	3.0
	Sensible Capacity	H	kW	1.6	2.1	3.0	3.6
		M	kW	1.3	1.3	2.4	3.0
		L	kW	1.0	1.5	2.0	2.4
	Water Flow Rate	L/h		345	460	650	770
	Water Pressure Drop	kPa		10	17	16	18
	Heating	2Pipe Heating Capacity	H	kW	2.8	4.0	5.4
M			kW	2.2	3.4	4.3	5.4
L			kW	1.8	2.8	3.6	4.3
4Pipe Heating Capacity		H	kW	1.7	2.3	3.0	3.7
		M	kW	1.3	1.9	2.4	3.0
		L	kW	1.1	1.6	2.0	2.4
Water Flow Rate		L/h		150	200	260	320
Water Pressure Drop		kPa		4	4	10	13
Power Input		W		60	65	67	95
Sound Pressure	dB(A)		37	39	41	43	
Motor	Type	3-speed Motor		3-speed Motor	3-speed Motor	3-speed Motor	
	Quantity	1		1	1	1	
Coil Rows	Nr.		2-Pipe System: 3Rows; 4-Pipe System: 3+1Rows				
Net Weight(With Feet)	2/4 Pipe	kg	19/20	21/22	26/28	26/28	
Net Weight(No Feet)	2/4 Pipe	kg	17/18	19/20	24/26	24/26	
Net Dimension(With Feet L×W×H)	mm		805×205×581	905×205×581	1105×205×581	1105×205×581	
Net Dimension(No Feet L×W×H)	mm		805×205×481	905×205×481	1105×205×481	1105×205×481	
Packing Dimension(With Feet L×W×H)	mm		895×250×520	995×250×520	1195×250×520	1195×250×520	
Packing Dimension(L×W×H)	mm		895×250×520	995×250×520	1195×250×520	1195×250×520	

Remark:  
 1. Cooling: Inlet air temp.(DB/WB):27°C/19.5°C; Water Inlet/Outlet:+7°C/+12°C;  
 2. Heating: +21°C; Water Inlet Temp.60°C; Same water Flow Rate as for the Cooling.  
 3. The data above is only for reference, designs and specifications might be changed without prior notice.



Model	/		FP-102UM	FP-136UM	FP-170UM	FP-204UM	
CFM	/		600	800	1000	1200	
Power Supply	/		220-240V/1N/50Hz	220-240V/1N/50Hz	220-240V/1N/50Hz	220-240V/1N/50Hz	
Air Flow Rate	H	m³/h	1020	1360	1700	2040	
	M	m³/h	850	1020	1360	1700	
	L	m³/h	650	850	1100	1360	
Cooling	Total Capacity	H	kW	5.5	7.4	9.0	10.8
		M	kW	4.6	5.6	7.3	9.0
		L	kW	3.5	4.6	5.9	7.3
	Sensible Capacity	H	kW	4.4	5.9	7.2	8.6
		M	kW	3.7	4.4	5.8	7.2
		L	kW	2.8	3.7	4.7	5.8
	Water Flow Rate	L/h		1030	1200	1550	1850
	Water Pressure Drop	kPa		23	29	38	40
	Heating	2Pipe Heating Capacity	H	kW	8.0	10.8	13.5
M			kW	7.0	8.0	11.0	13.5
L			kW	5.5	7.0	8.9	11.0
4Pipe Heating Capacity		H	kW	4.3	5.8	7.4	8.8
		M	kW	3.6	4.4	5.9	7.4
		L	kW	2.7	3.6	4.8	5.9
Water Flow Rate		L/h		370	500	640	760
Water Pressure Drop		kPa		17	21	30	35
Power Input		W		105	156	183	190
Sound Pressure	dB(A)		45	46	50	52	
Motor	Type	3-speed Motor		3-speed Motor	3-speed Motor	3-speed Motor	
	Quantity	2		2	2	2	
Coil Rows	Nr.		2-Pipe System: 3Rows; 4-Pipe System: 3+1Rows				
Net Weight(With Feet)	2/4 Pipe	kg	38/40	38/40	44/48	44/48	
Net Weight(No Feet)	2/4 Pipe	kg	36/38	36/38	42/46	42/46	
Net Dimension(With Feet L×W×H)	mm		1605×205×581	1605×205×581	1905×205×581	1905×205×581	
Net Dimension(No Feet L×W×H)	mm		1605×205×481	1605×205×481	1905×205×481	1905×205×481	
Packing Dimension(With Feet L×W×H)	mm		1695×250×520	1695×250×520	1995×250×520	1995×250×520	
Packing Dimension(L×W×H)	mm		1695×250×520	1695×250×520	1995×250×520	1995×250×520	

Remark:  
 1. Cooling: Inlet air temp.(DB/WB):27°C/19.5°C; Water Inlet/Outlet:+7°C/+12°C;  
 2. Heating: +21°C; Water Inlet Temp.60°C; Same water Flow Rate as for the Cooling.  
 3. The data above is only for reference, designs and specifications might be changed without prior notice.



# Concealed Fan Coil

High Static Pressure: 110Pa



## Dimensions:

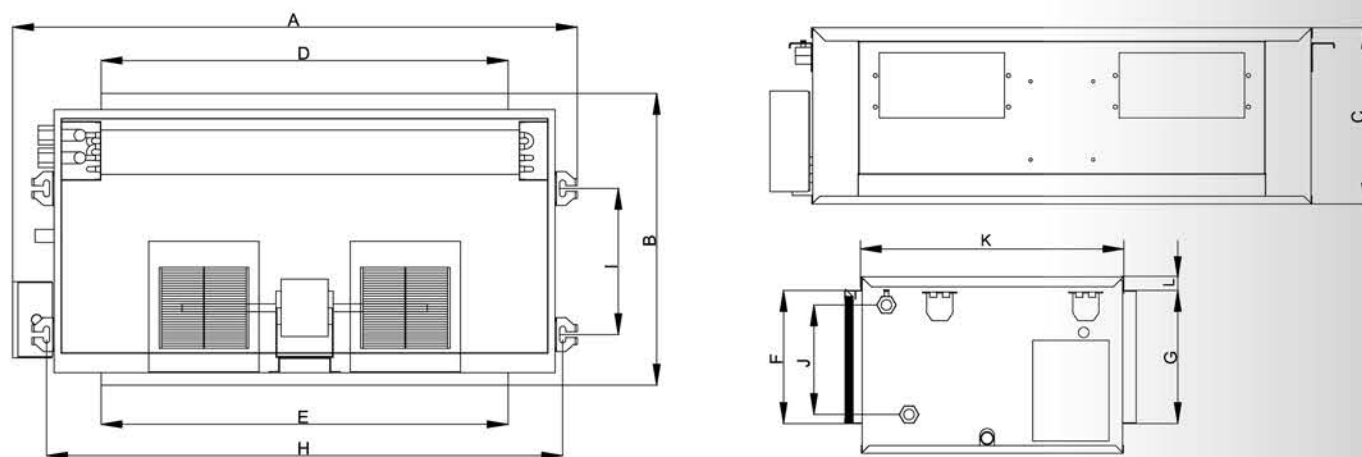

Model	A	B	C	D	E	F	G	H	I	J	K	L
GFP-136WAV	1090	568	340	780	780	255	255	1000	280	213	504	26
GFP-170WAV	1190	568	340	880	880	255	255	1100	280	213	504	26
GFP-204WAV	1290	568	390	980	980	305	305	1200	280	260	504	26
GFP-238WAV	1450	688	390	1140	1000	305	305	1360	425	260	624	26
GFP-289WAV	1490	688	450	1180	1100	365	305	1400	425	310	624	26
GFP-340WAV	1620	863	450	1310	1200	365	305	1530	425	310	798	26
GFP-408WAV	1640	863	500	1330	1200	355	355	1550	575	360	798	26
GFP-510WAV	1940	863	500	1660	1500	355	355	1880	575	360	798	26

Unit: mm

## Specification

### Centrifugal Fan

Well-known brand centrifugal fans, with galvanized steel and which is statically and dynamically balanced.

### Condensate Drain Pan

L shaped drain pan, suitable for horizontal and/or vertical installation.

### High Efficiency Coil

Coil are made of copper tubes and high exchange surface are aluminum blue fins. All coils are 100% tested against leaks by 30bar(3Mpa) with 3/4" pipe connections are air bleed vent.



Model	/	GFP-136WAV	GFP-170WAV	GFP-204WAV	GFP-238WAV	GFP-289WAV	GFP-340WAV	GFP-408WAV	GFP-510WAV	
Power Supply	/	220-240V/1N/50Hz								
Air Flow Rate	H m³/h	1001	1516	2053	2406	3267	3590	4108	5070	
	M m³/h	892	1213	1643	1925	2613	2684	3286	3802	
	L m³/h	669	910	1232	1444	1960	2013	2465	2851	
Cooling	Total Capacity	H kW	6.4	9.1	12.6	15.1	19.8	22.2	25.6	32.6
		M kW	5.9	7.8	10.8	12.9	17.0	18.1	21.9	26.6
		L kW	4.8	6.4	8.8	10.5	13.8	14.7	17.8	21.5
	Sensible Capacity	H kW	4.5	6.5	8.8	10.5	13.9	15.4	17.7	22.3
		M kW	4.1	5.5	7.5	8.9	11.7	12.4	15.0	18.0
		L kW	3.3	4.4	6.0	7.1	9.4	9.9	12.0	14.3
Water Flow Rate	L/h	1116	1584	2160	2592	3420	3816	4392	5616	
Water Pressure Drop	kPa	11.2	19.2	25.1	36.2	43.2	54.8	56.1	93.4	
Heating	Heating Capacity	H kW	7.7	10.9	14.8	17.5	23.1	25.5	29.3	36.7
		M kW	7.0	9.2	12.5	14.8	19.5	20.5	24.8	29.5
		L kW	5.6	7.4	10.0	11.8	15.6	16.4	19.9	23.5
Power Input	W	368	460	564	650	845	934	1128	1445	
Sound Pressure	dB(A)	50	52	55	58	59	60	64	68	
Motor	Type	3-speed Motor	3-speed Motor	3-speed Motor	3-speed Motor	3-speed Motor	3-speed Motor	3-speed Motor	3-speed Motor	
	Input Power	368	460	564	650	845	934	1128	1445	
Coil Rows	Nr.	4.0	4.0	4.0	4.0	4.0	4.0	4.0	4.0	
Net Weight	kg	35	44	55	62	74	80	93	98	
Net Dimension(L×W×H)	mm	1090×568×340	1190×568×340	1290×568×390	1450×688×390	1490×688×450	1620×863×500	1640×863×500	1970×863×500	
Packing Dimension(L×W×H)	mm	1130×610×350	1230×610×350	1330×610×400	1490×725×400	1535×730×460	1660×905×510	1680×905×510	2010×905×510	

### Remark:

1. Cooling: Inlet air temp.(DB/WB):27°C/19.5°C; Water Inlet/Outlet:+7°C/+12°C;
2. Heating: Inlet air temp.(DB) :21°C; Water Inlet Temp.60°C; Same water Flow Rate as for Cooling.
3. Testing static pressure ESP:110Pa
4. The data above is only for reference,designs and specifications might be changed without prior notice.



Note

OUTES

Note

OUTES



## Note

OUTES